

EXPLODED DRAWING A

Model No. PFTL60916.6 R0318B

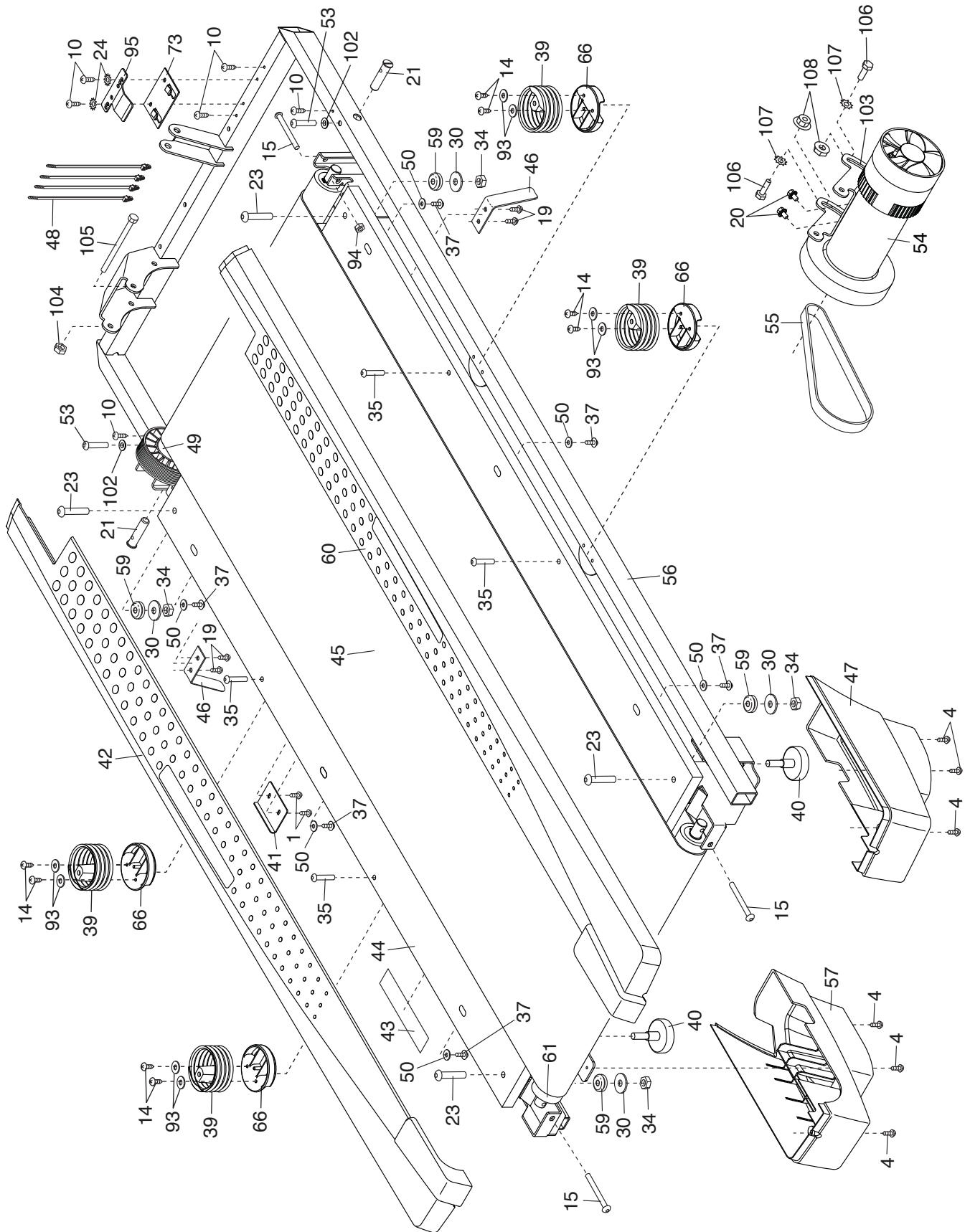

EXPLODED DRAWING B

Model No. PFTL60916.6 R0318B

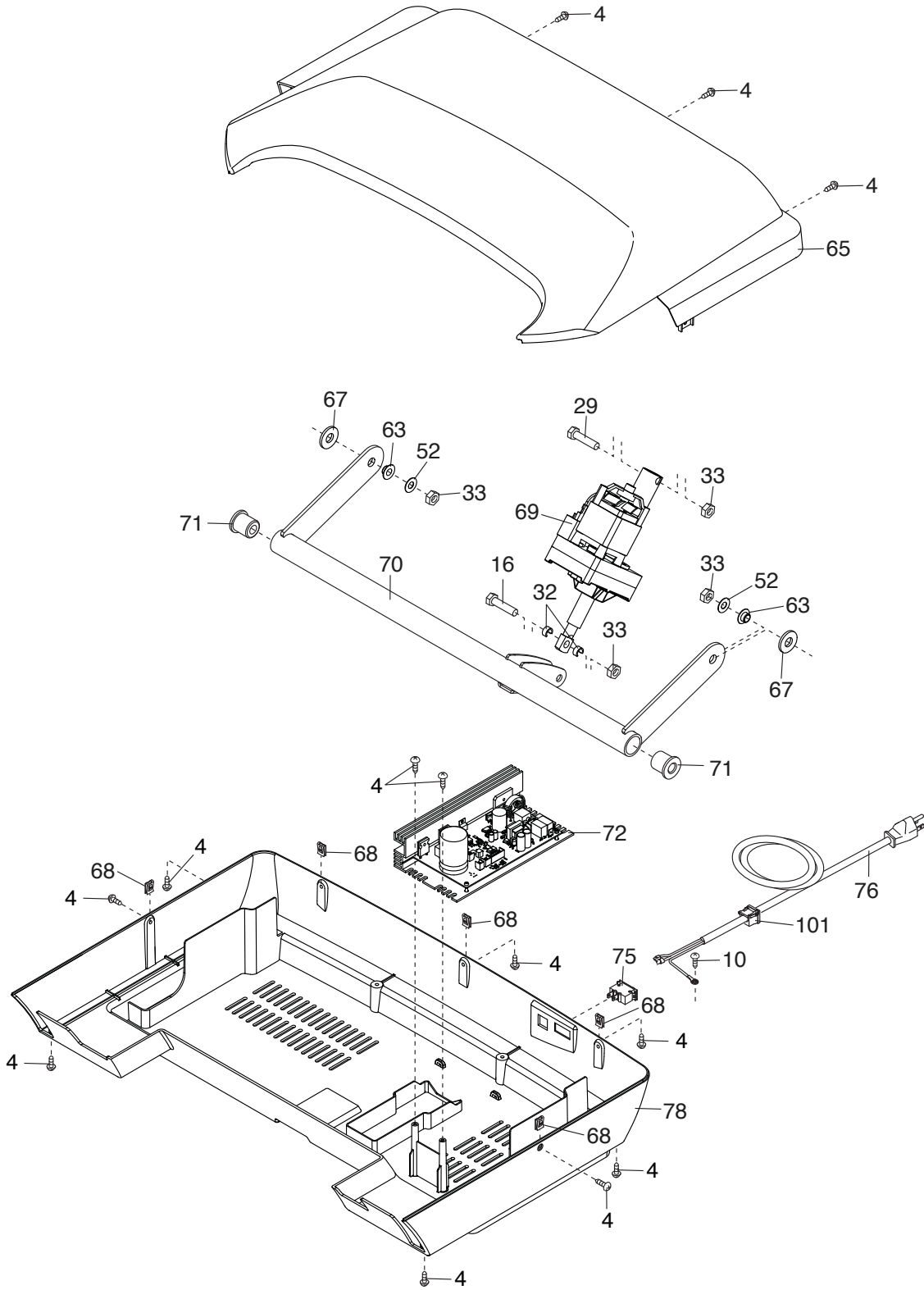

EXPLODED DRAWING C

Model No. PFTL60916.6 R0318B

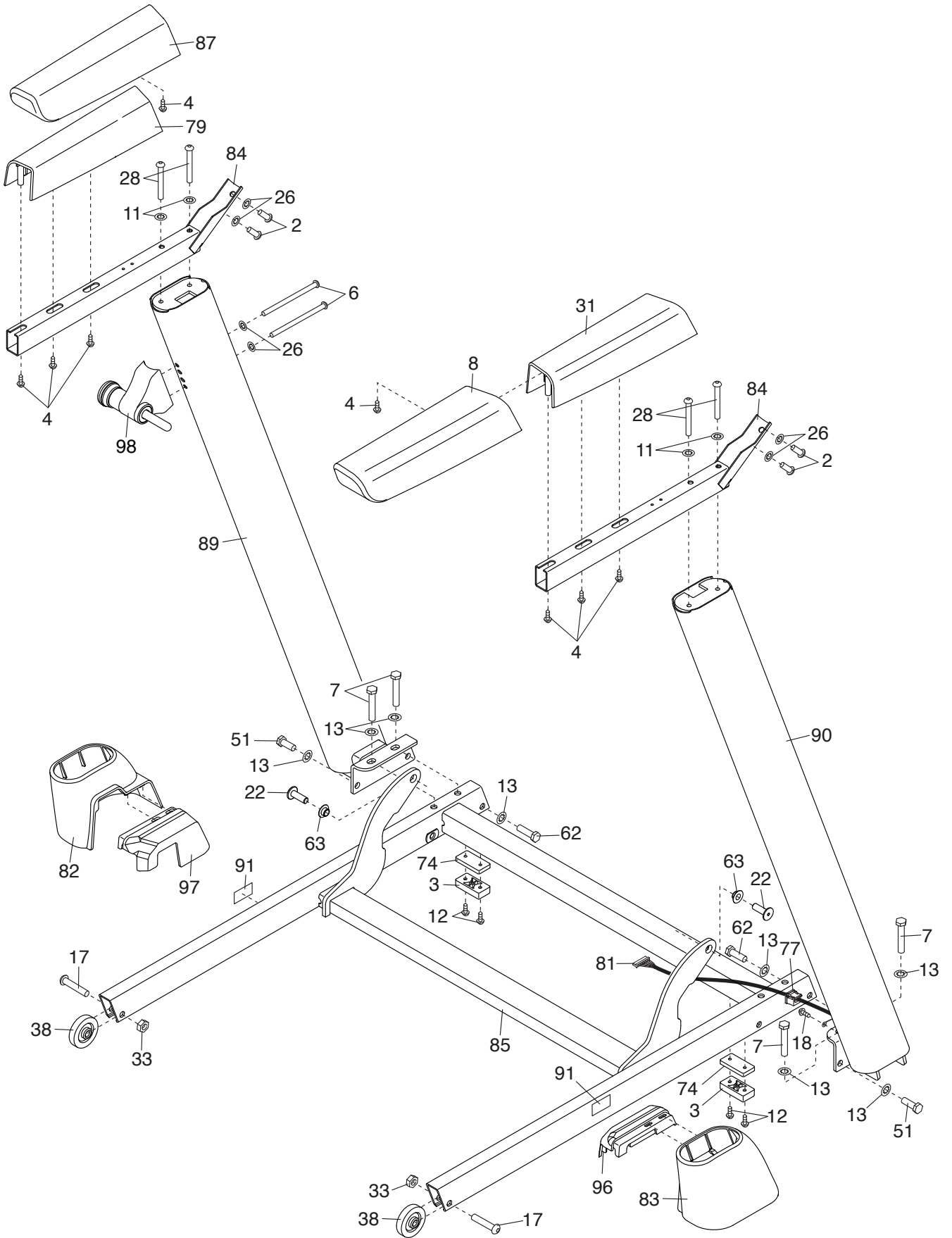

EXPLODED DRAWING D

Model No. PFTL60916.6 R0318B

