

EXPLODED DRAWING A

Model No. PFTL60918.0 R0718A

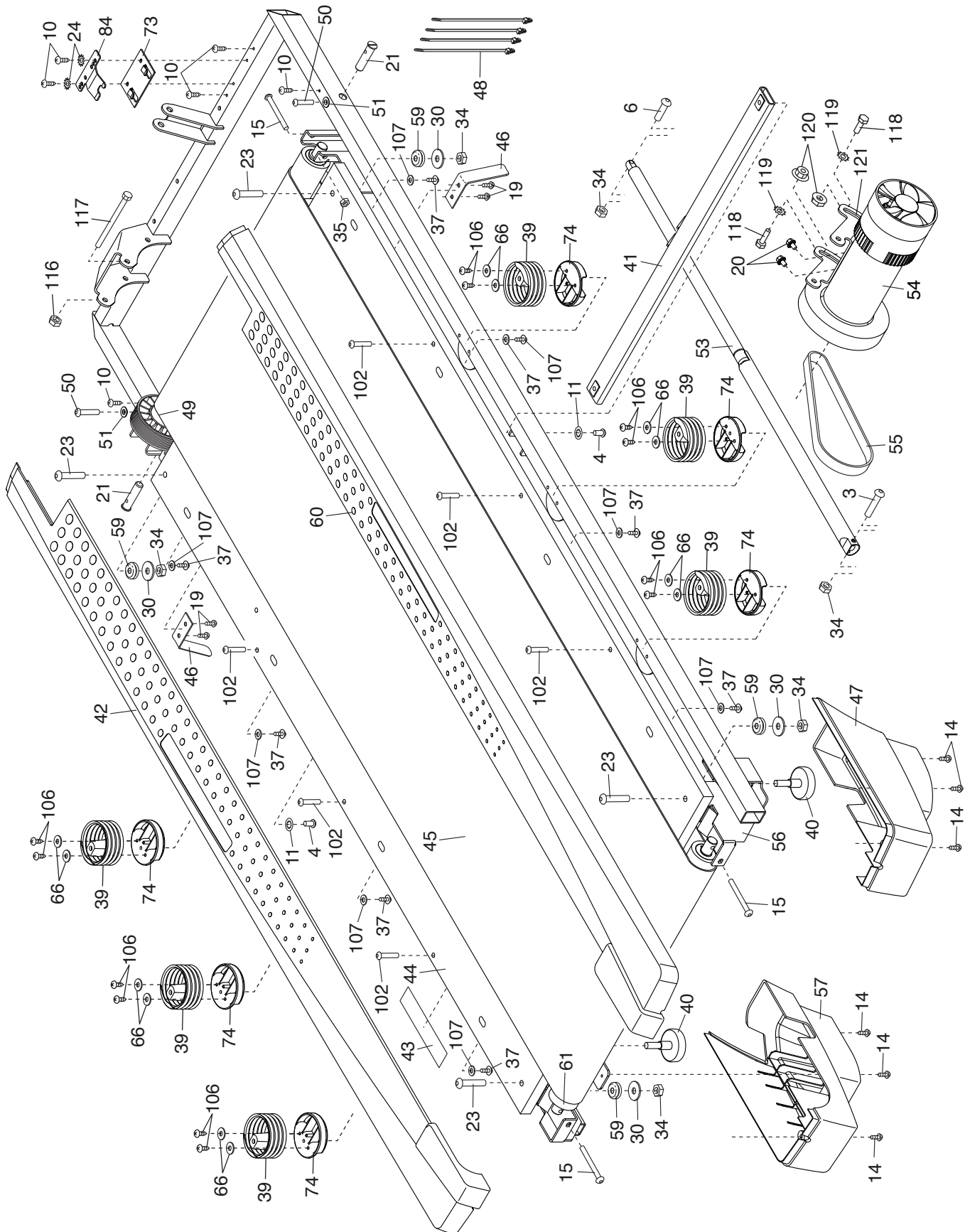

EXPLODED DRAWING B

Model No. PFTL60918.0 R0718A

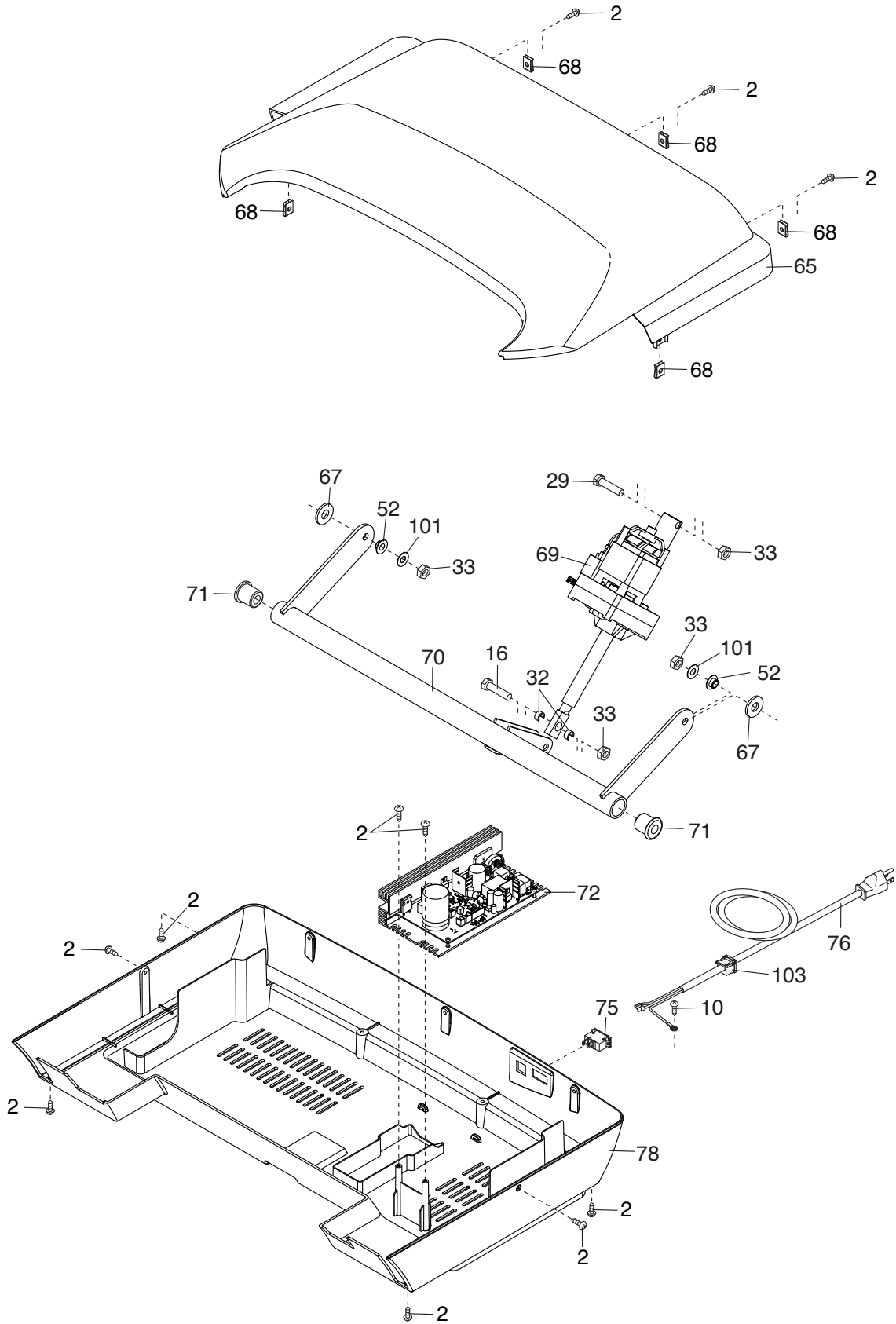

EXPLODED DRAWING C

Model No. PFTL60918.0 R0718A

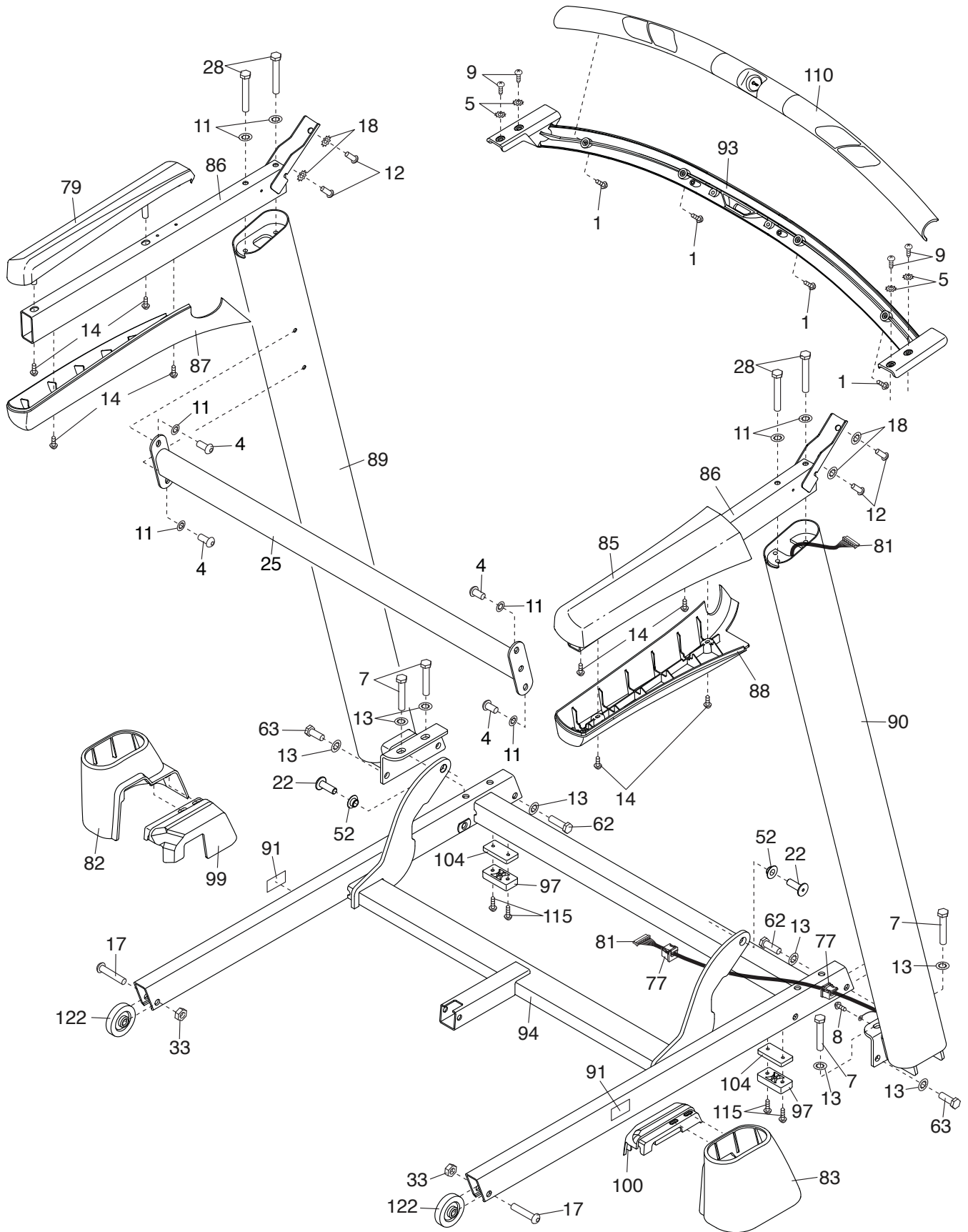

EXPLODED DRAWING D

Model No. PFTL60918.0 R0718A

