

EXPLODED DRAWING A—Model No. PFTL63609.1

R0910A

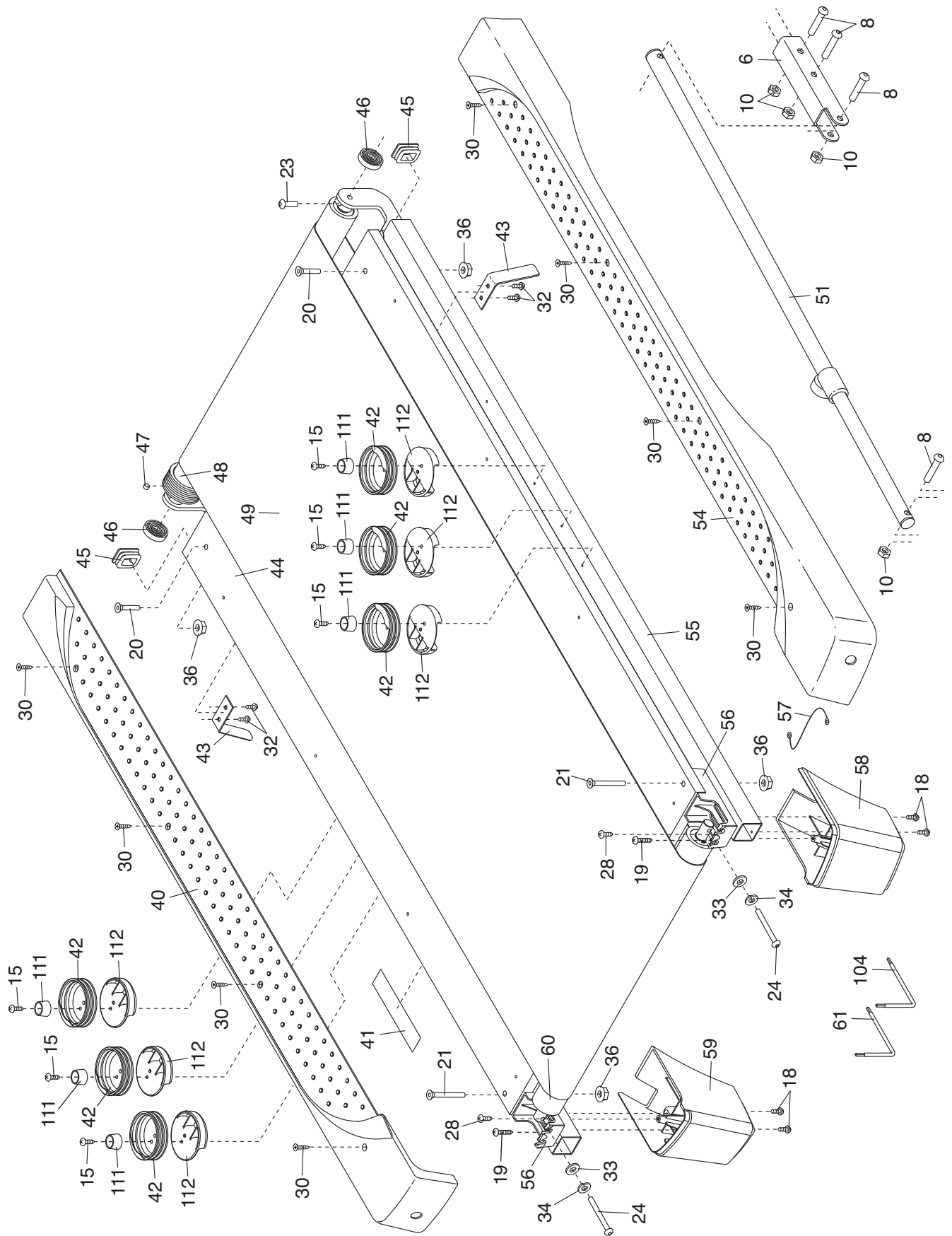

EXPLODED DRAWING B—Model No. PFTL63609.1

R0910A

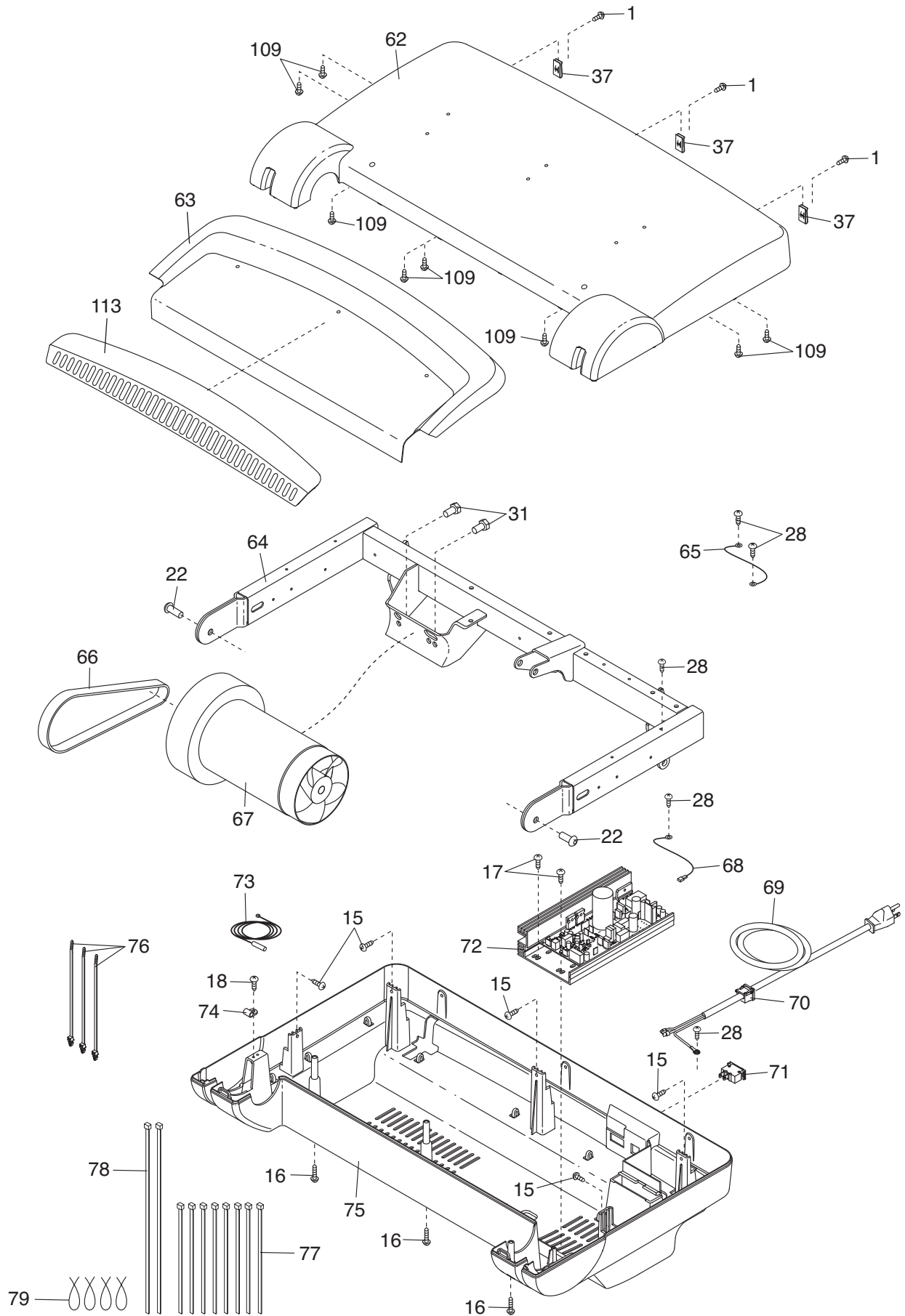

EXPLODED DRAWING C—Model No. PFTL63609.1

R0910A

