

EXPLODED DRAWING A—Model No. PFTL66010.0

R0410A

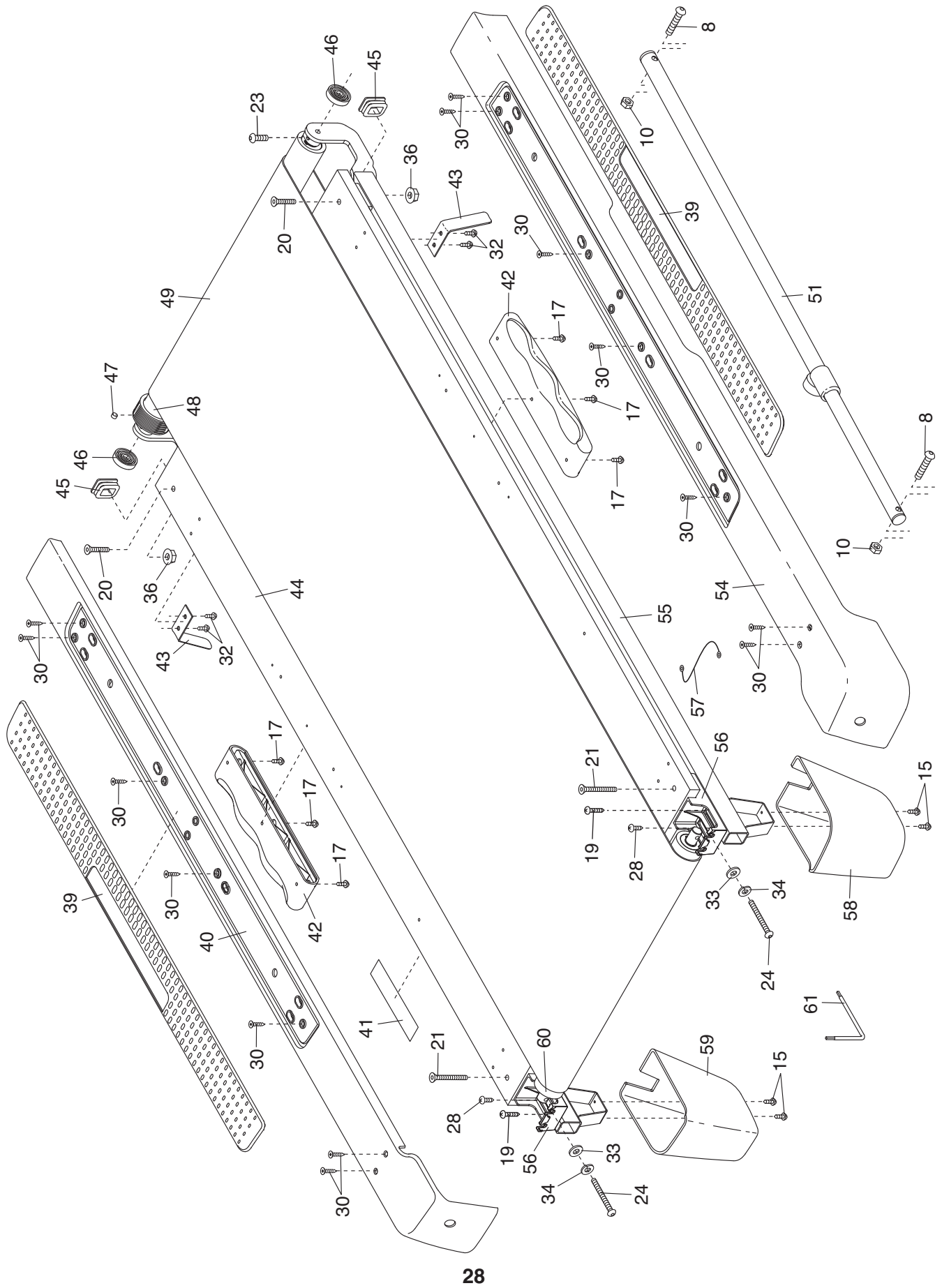

EXPLODED DRAWING B—Model No. PFTL66010.0

R0410A

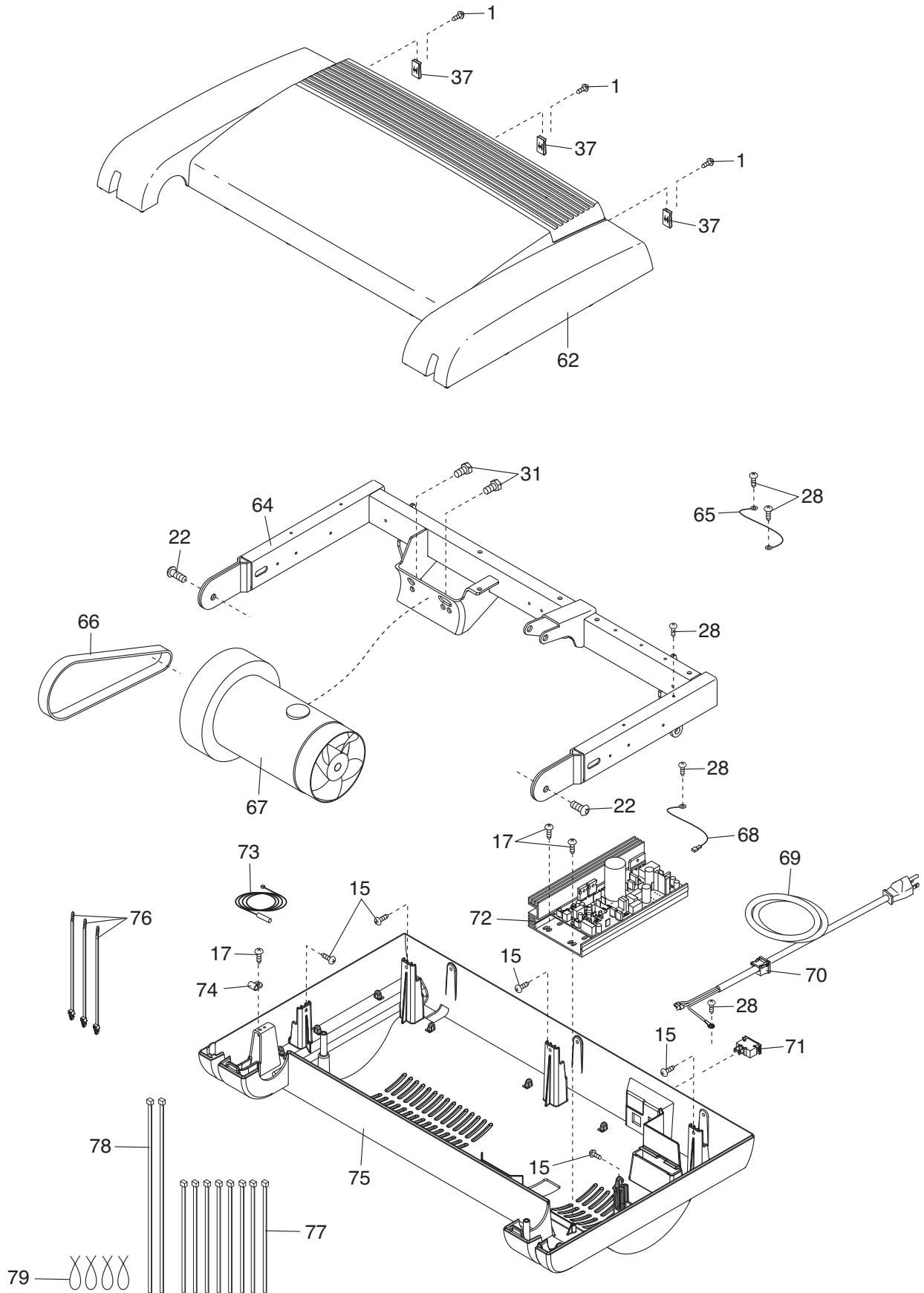

EXPLODED DRAWING C—Model No. PFTL66010.0

R0410A

