

EXPLODED DRAWING B

Model No. PFTL68011.0 R0411A

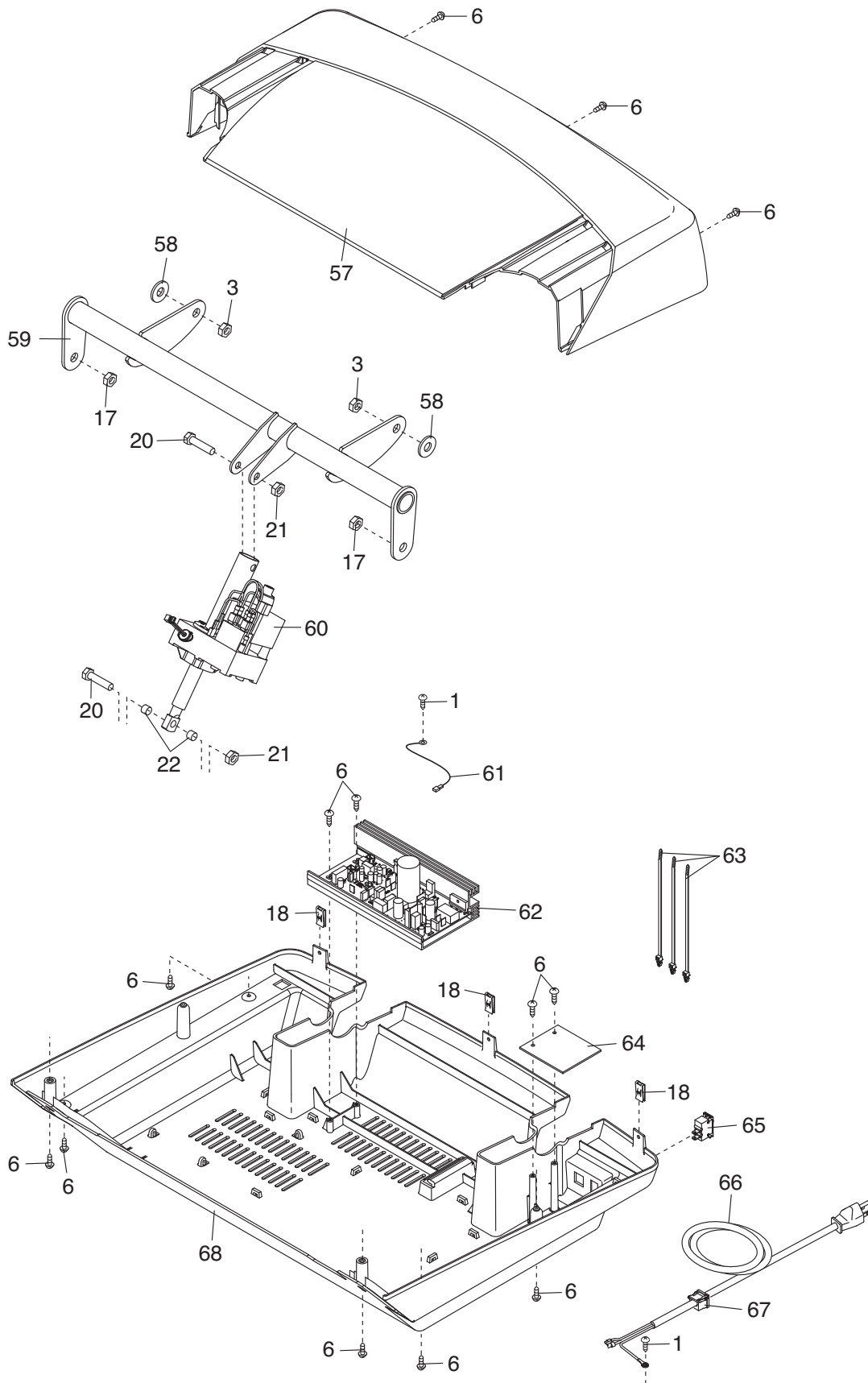

EXPLODED DRAWING C

Model No. PFTL68011.0 R0411A

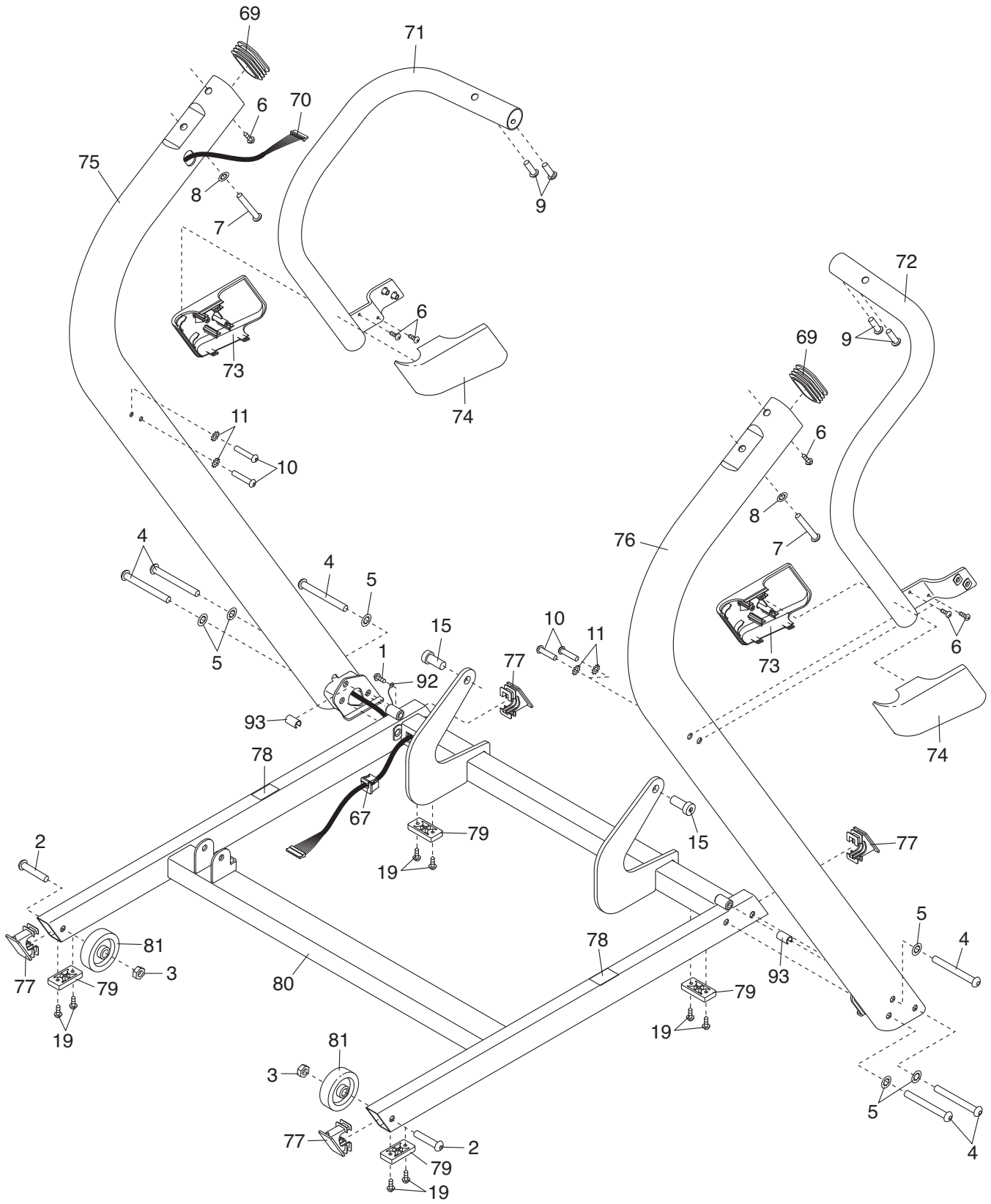

EXPLODED DRAWING D

Model No. PFTL68011.0 R0411A

