

EXPLODED DRAWING A

Model No. PFTL68011.1 R0412A

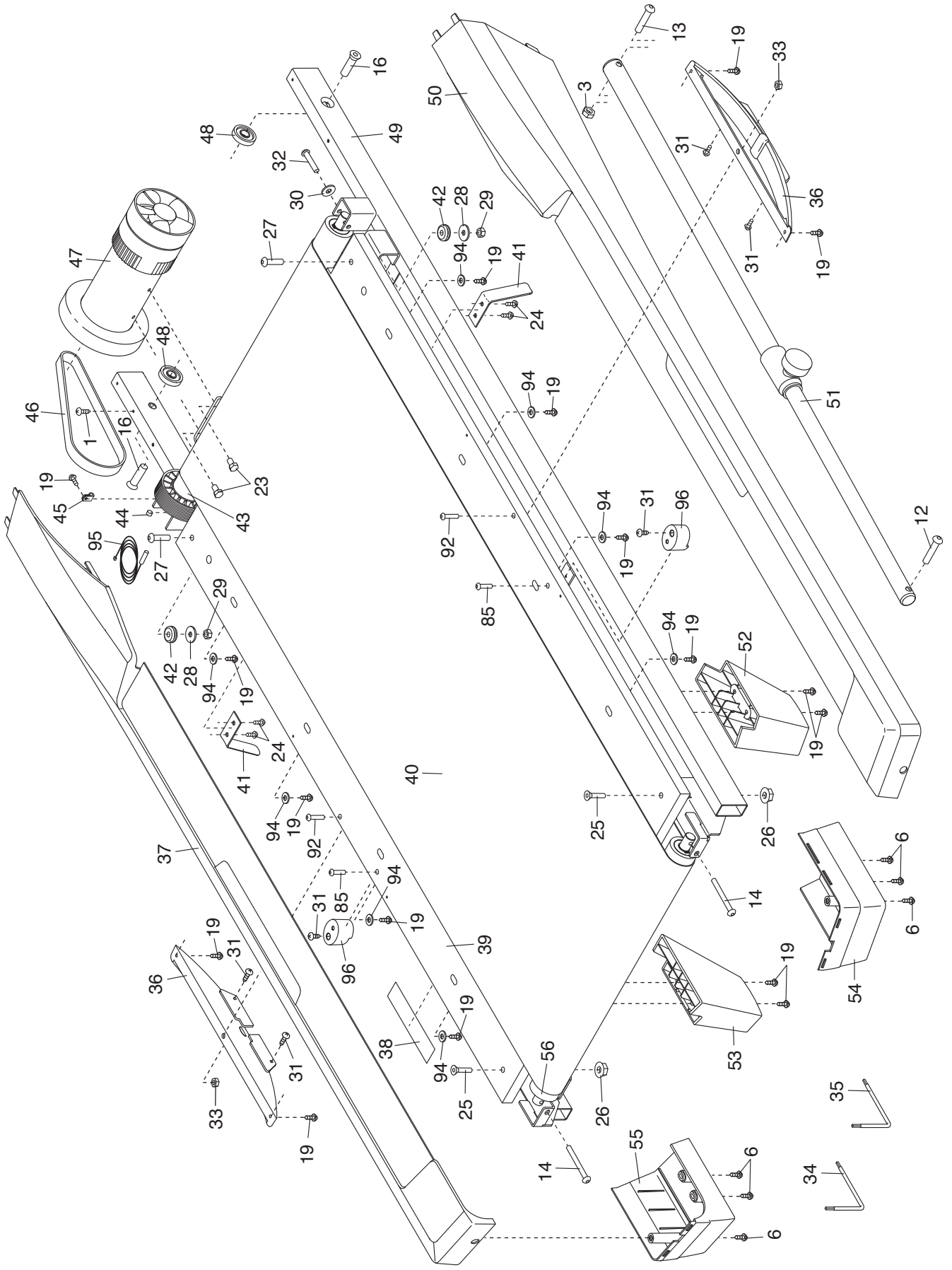

EXPLODED DRAWING B

Model No. PFTL68011.1 R0412A

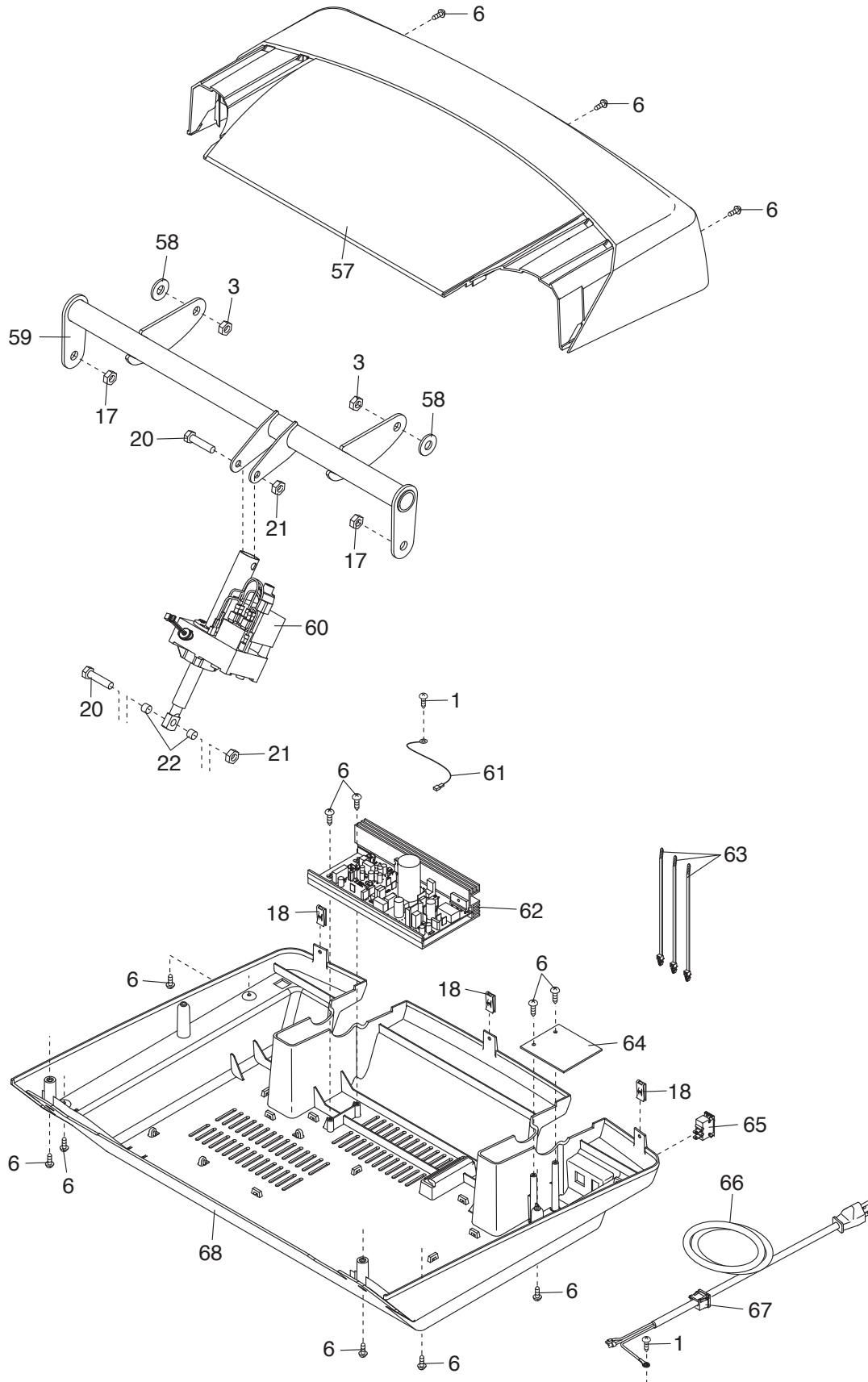

EXPLODED DRAWING C

Model No. PFTL68011.1 R0412A

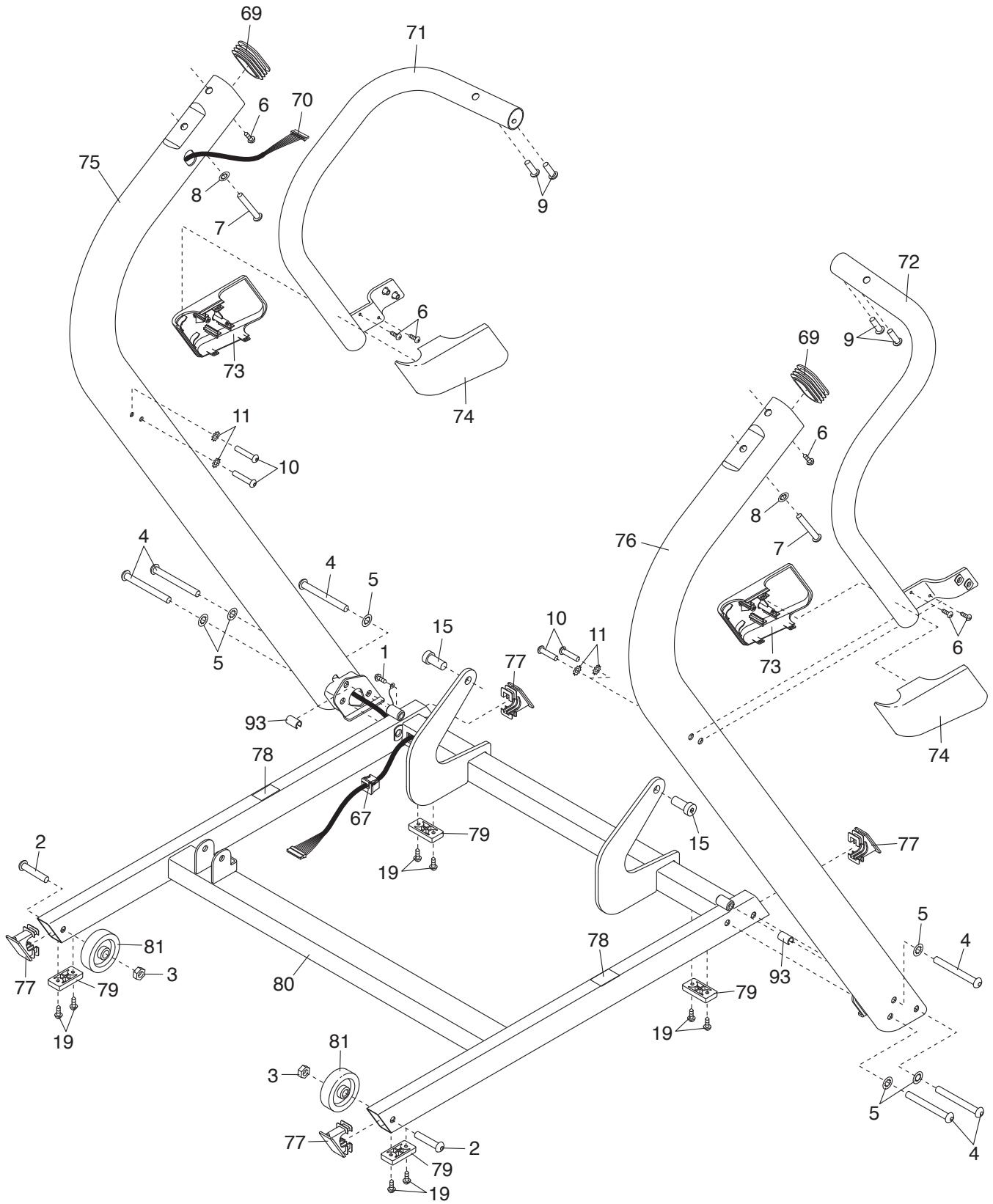

EXPLODED DRAWING D

Model No. PFTL68011.1 R0412A

