

EXPLODED DRAWING A

Model No. PFTL69618.0 R0818A

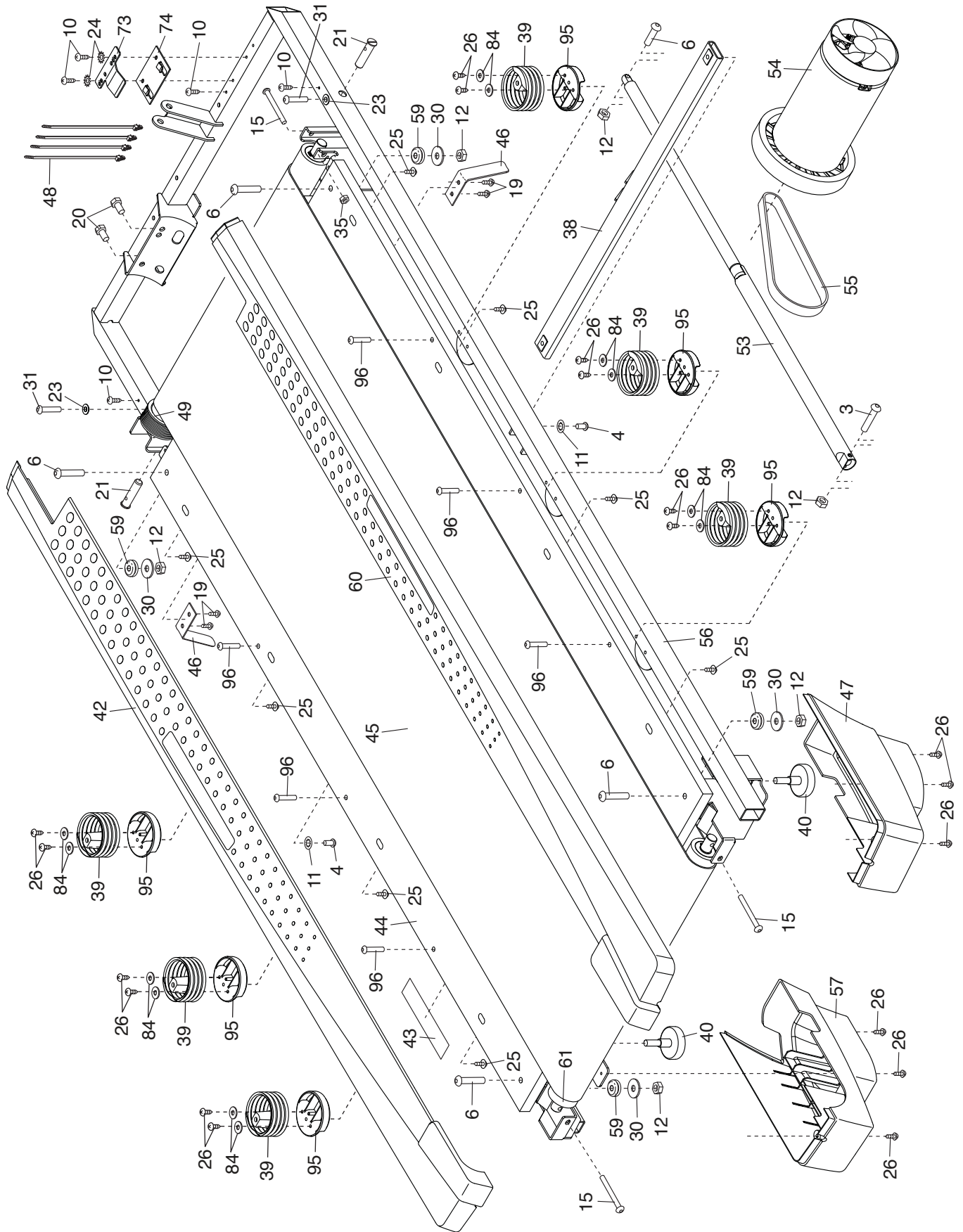

EXPLODED DRAWING B

Model No. PFTL69618.0 R0818A

