

EXPLODED DRAWING—Model No. PFTL69806.0

R0706A

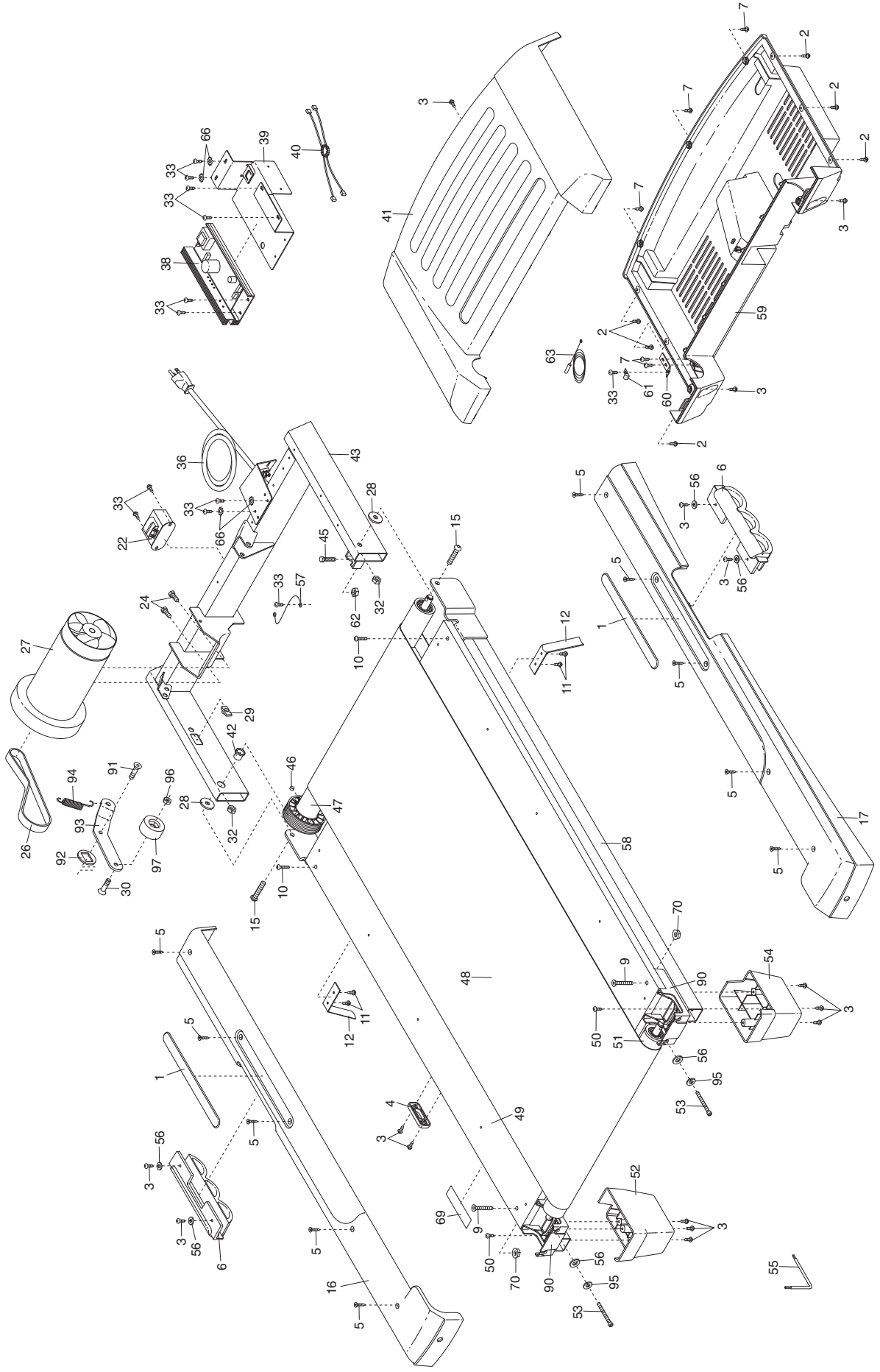

EXPLODED DRAWING—Model No. PFTL69806.0

R0706A

