

EXPLODED DRAWING A—Model No. PFTL70009.0

R0110A

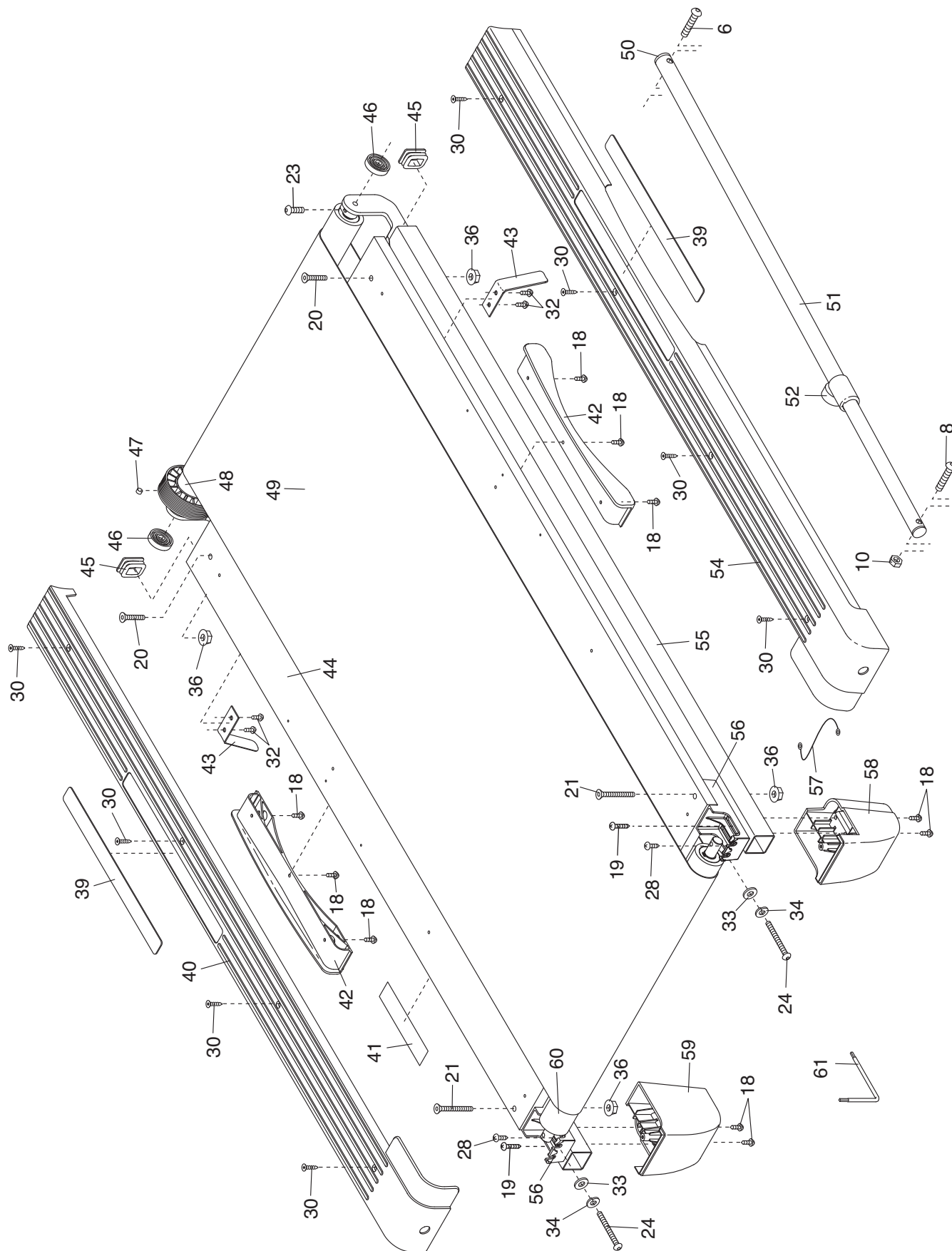

EXPLODED DRAWING B—Model No. PFTL70009.0

R0110A

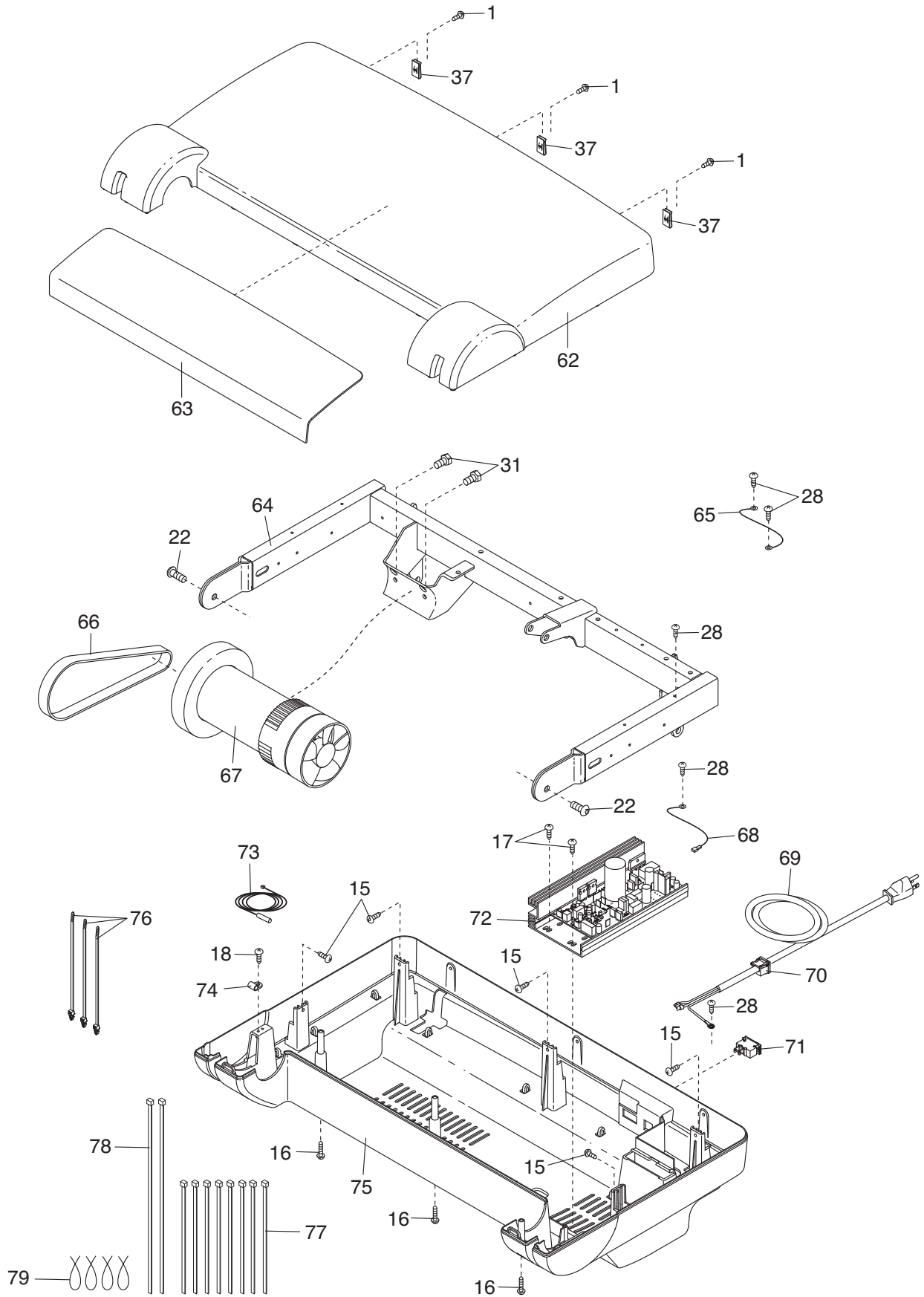

EXPLODED DRAWING C—Model No. PFTL70009.0

R0110A

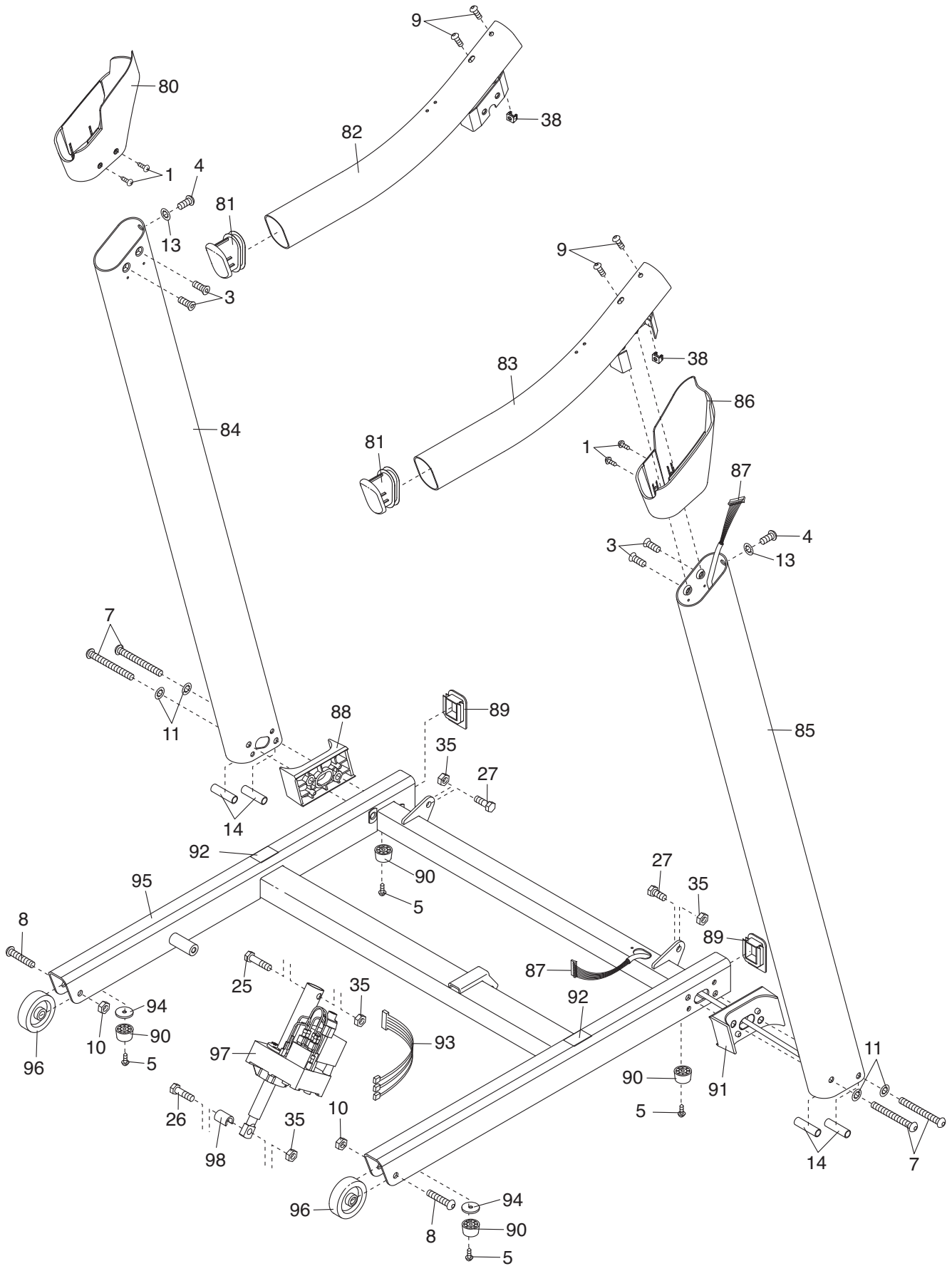

EXPLODED DRAWING D—Model No. PFTL70009.0

R0110A

