

EXPLODED DRAWING B

Model No. PFTL70010.0 R1210A

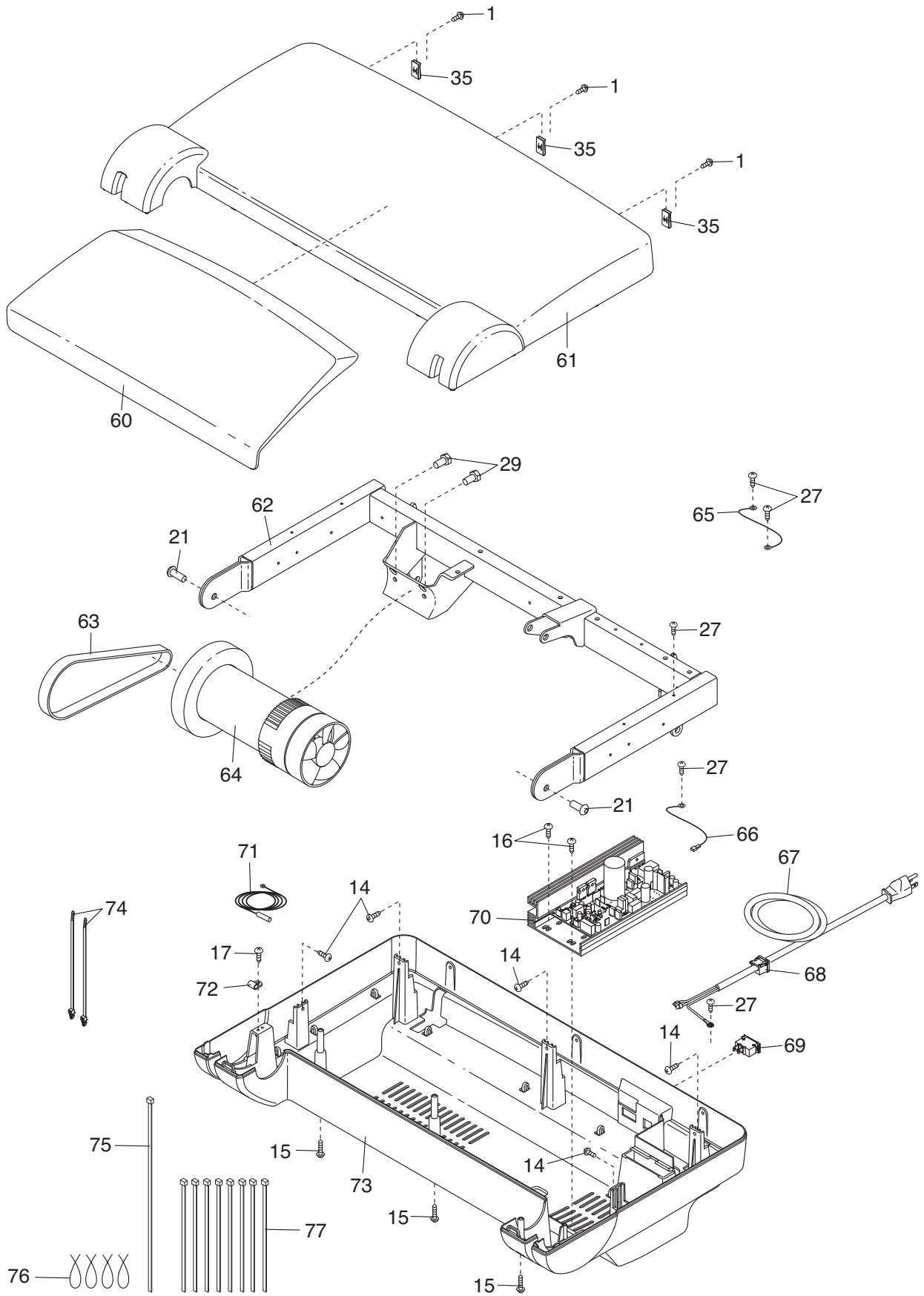

EXPLODED DRAWING C

Model No. PFTL70010.0 R1210A

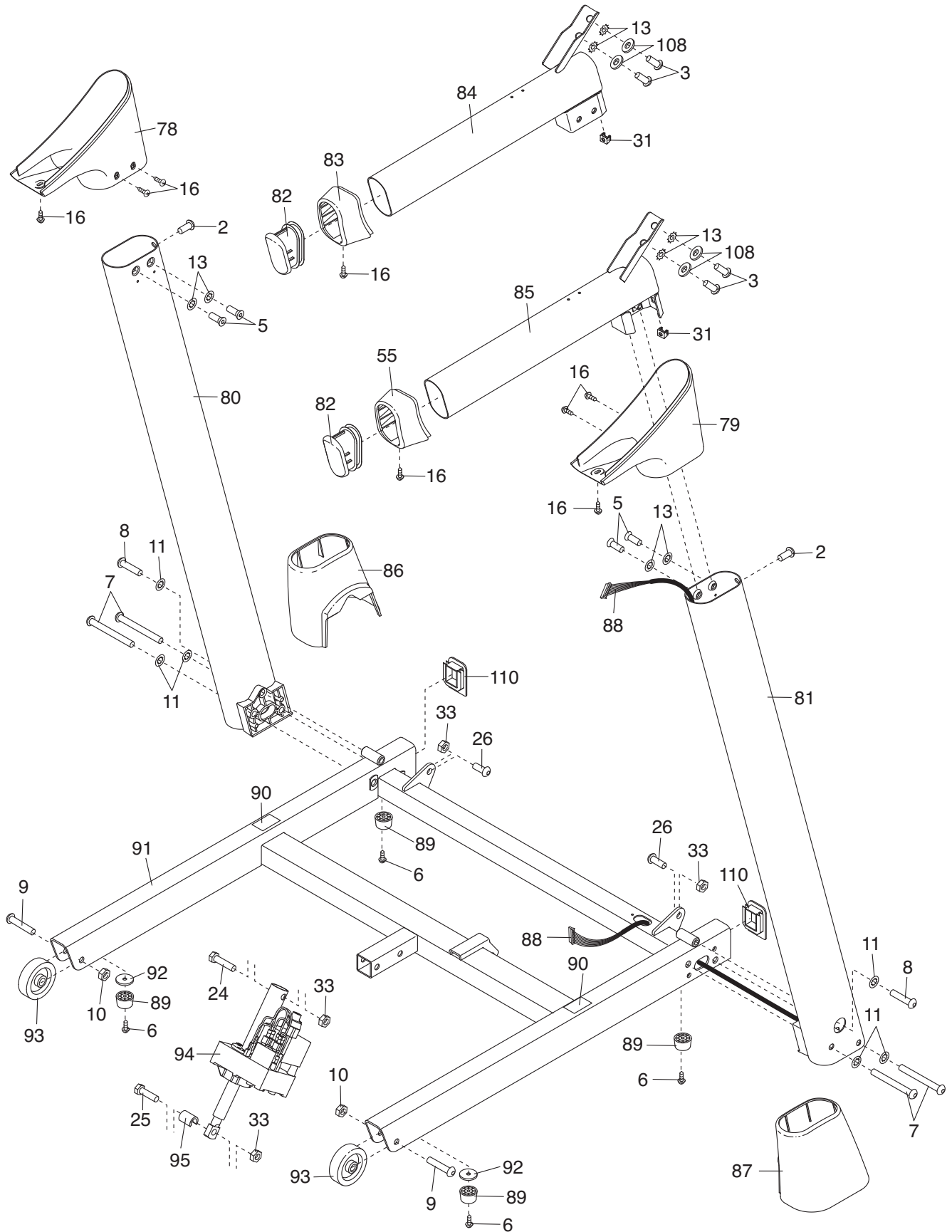

EXPLODED DRAWING D

Model No. PFTL70010.0 R1210A

