

EXPLODED DRAWING A

Model No. PFTL70012.3 R0514A

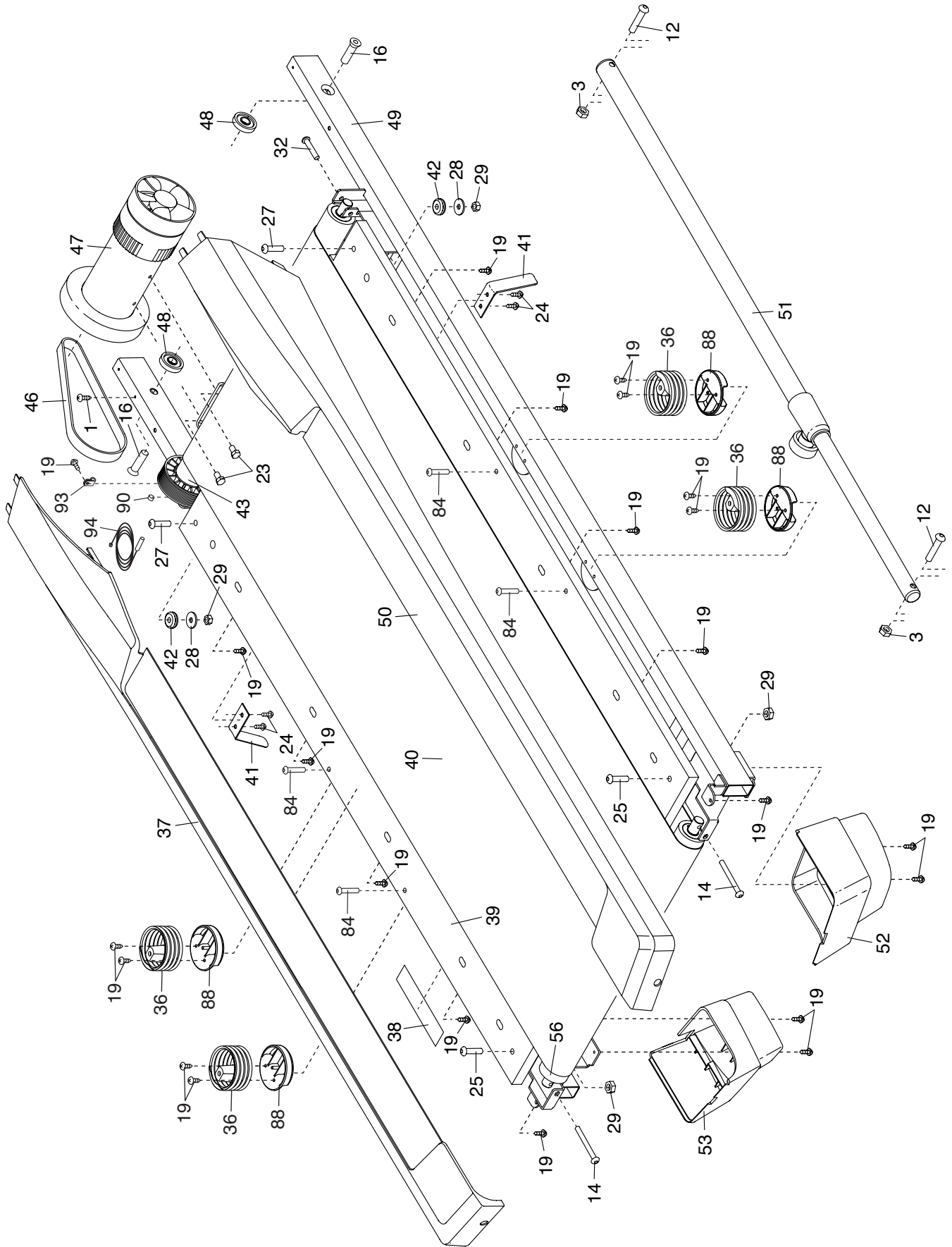

EXPLODED DRAWING B

Model No. PFTL70012.3 R0514A

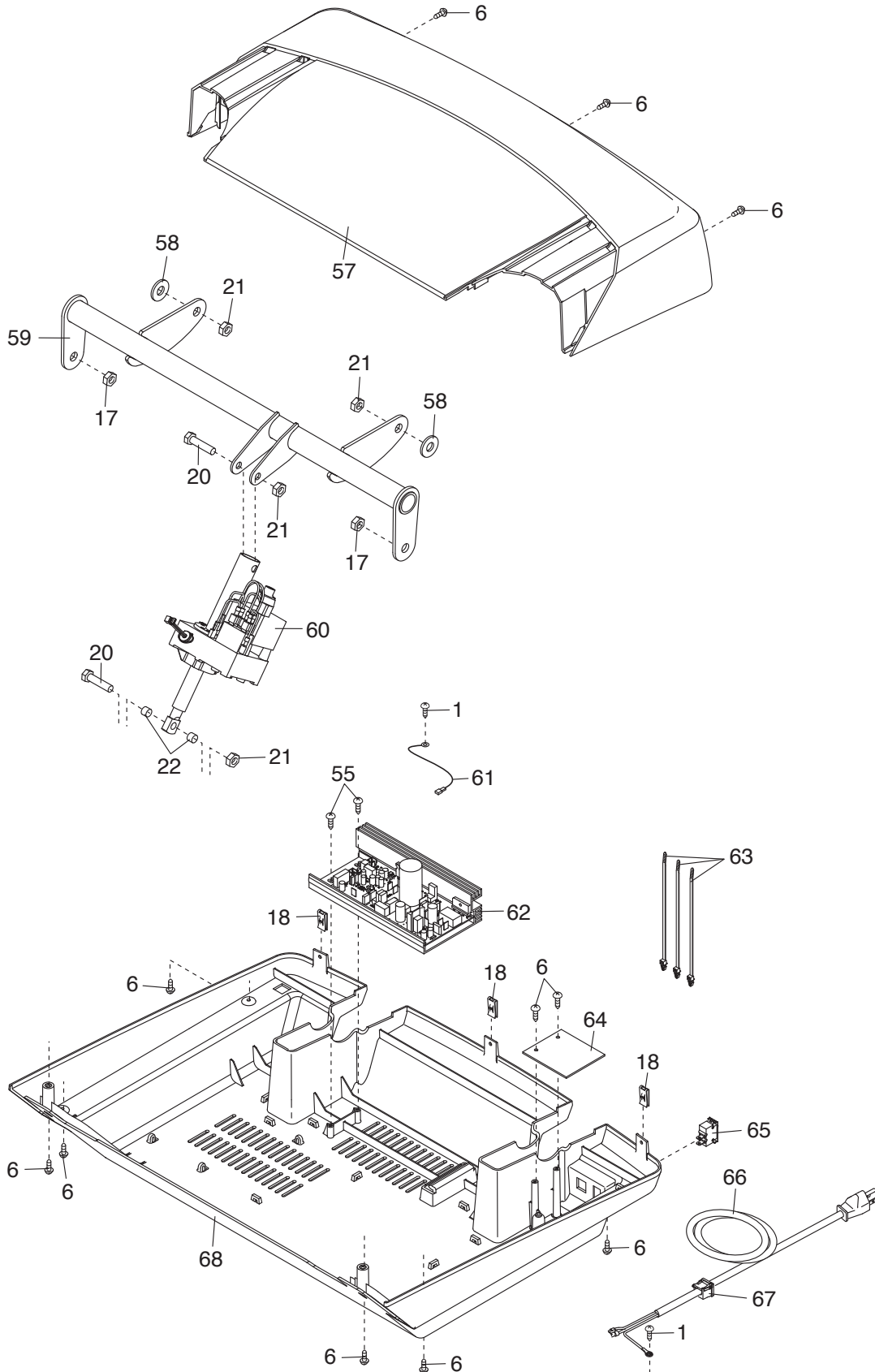

EXPLODED DRAWING C

Model No. PFTL70012.3 R0514A

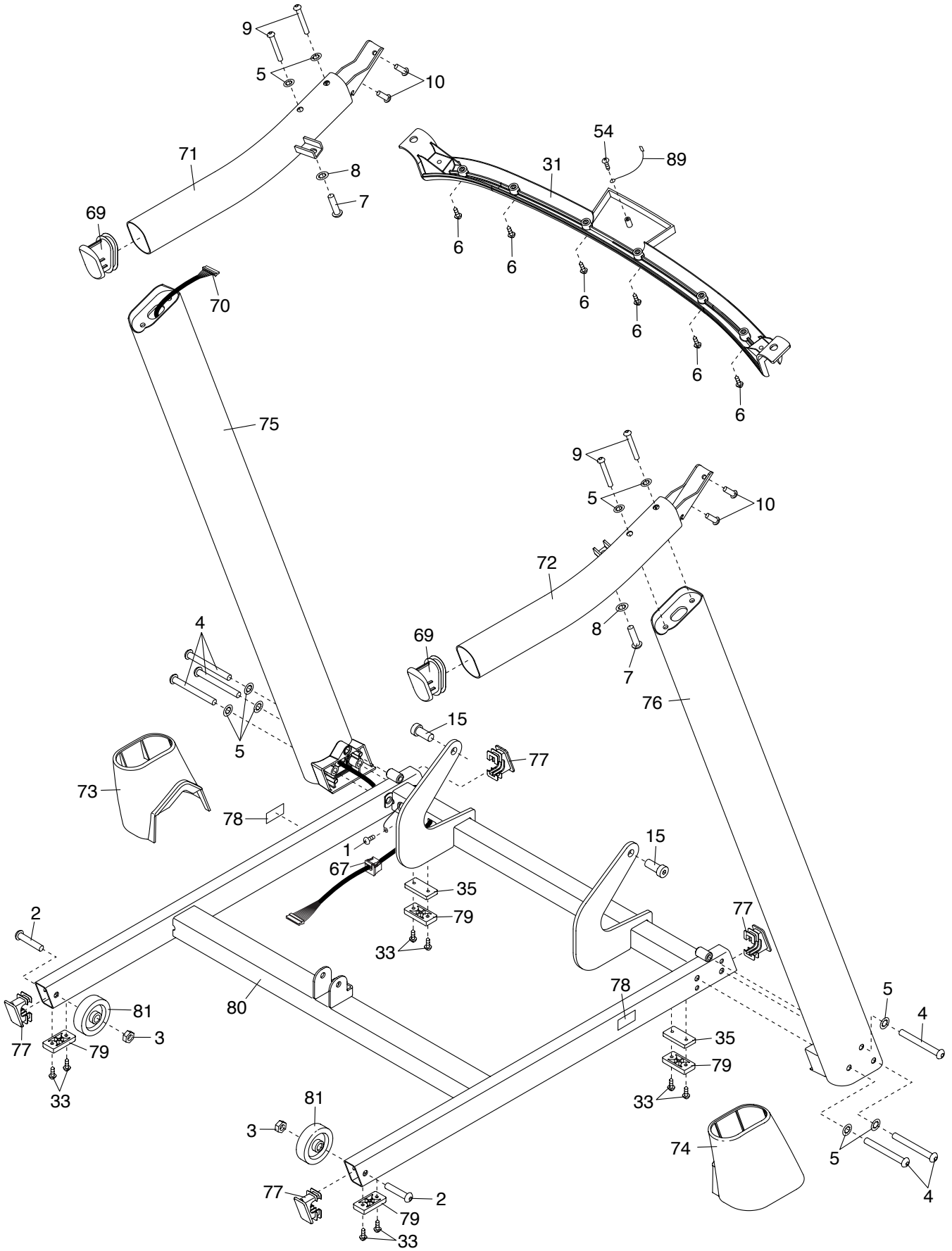

EXPLODED DRAWING D

Model No. PFTL70012.3 R0514A

