

EXPLODED DRAWING A

Model No. PFTL70015.3 R1017A

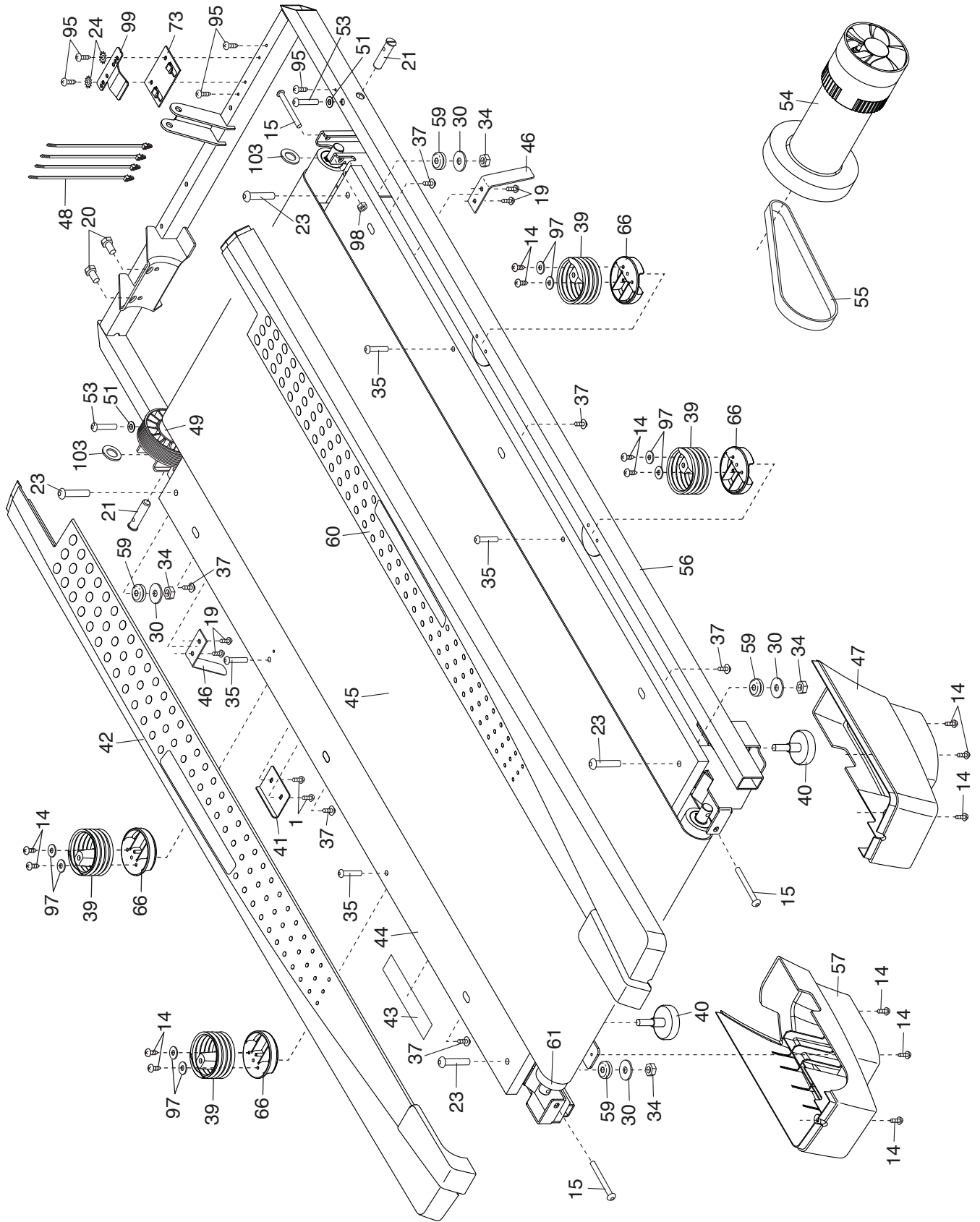

EXPLODED DRAWING B

Model No. PFTL70015.3 R1017A

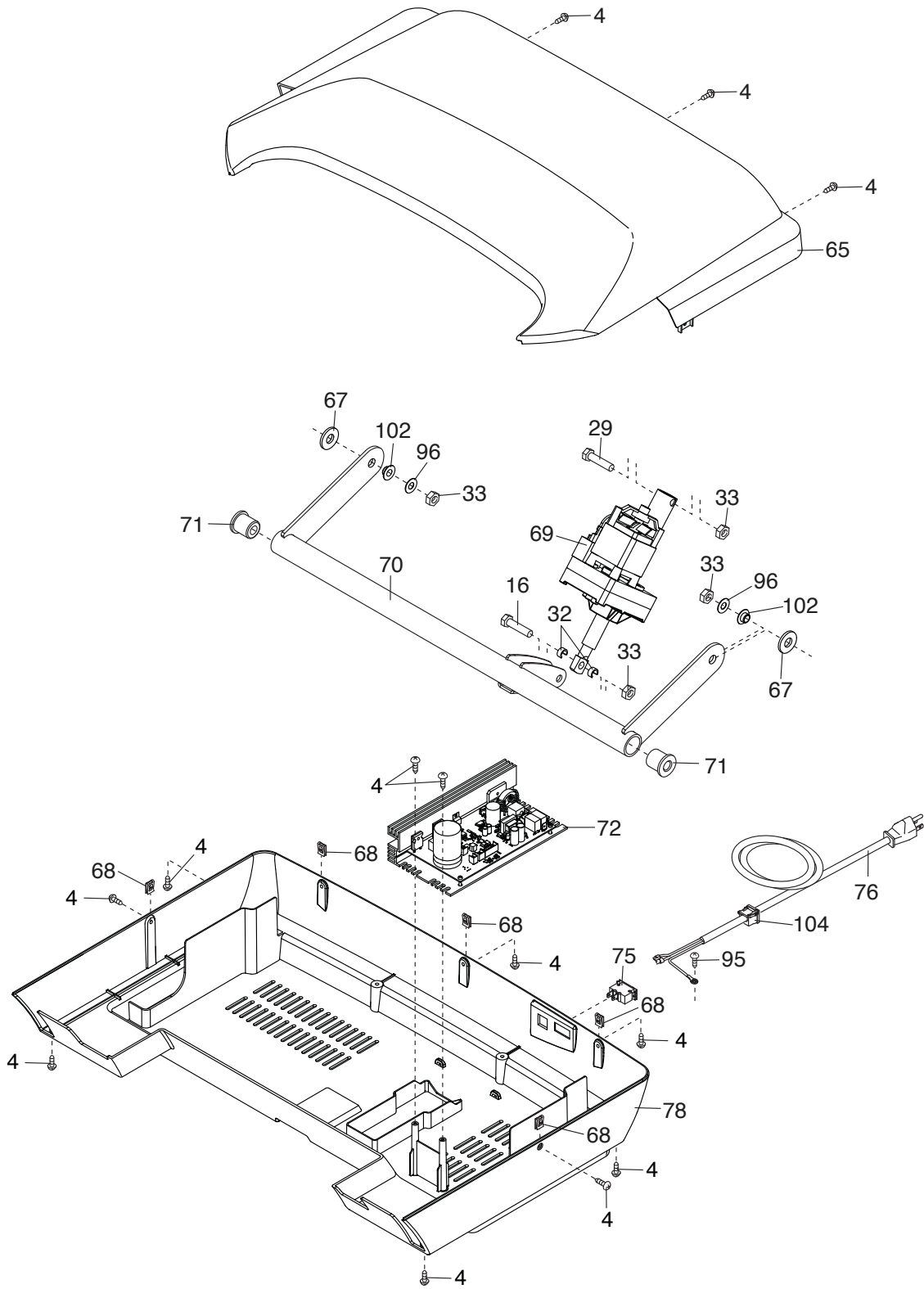

EXPLODED DRAWING C

Model No. PFTL70015.3 R1017A

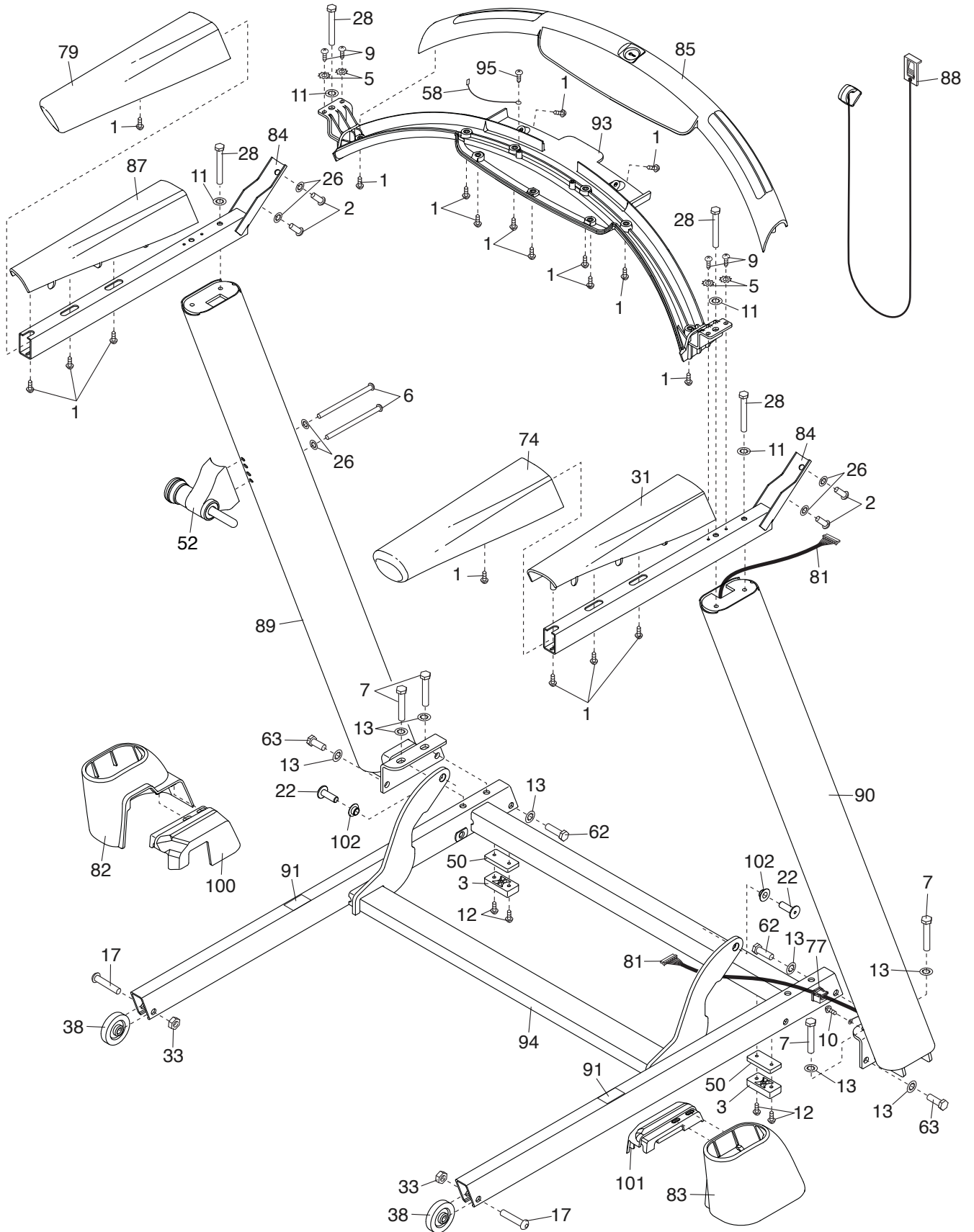

EXPLODED DRAWING D

Model No. PFTL70015.3 R1017A

