

EXPLODED DRAWING—Model No. PFTL709940

R1104A

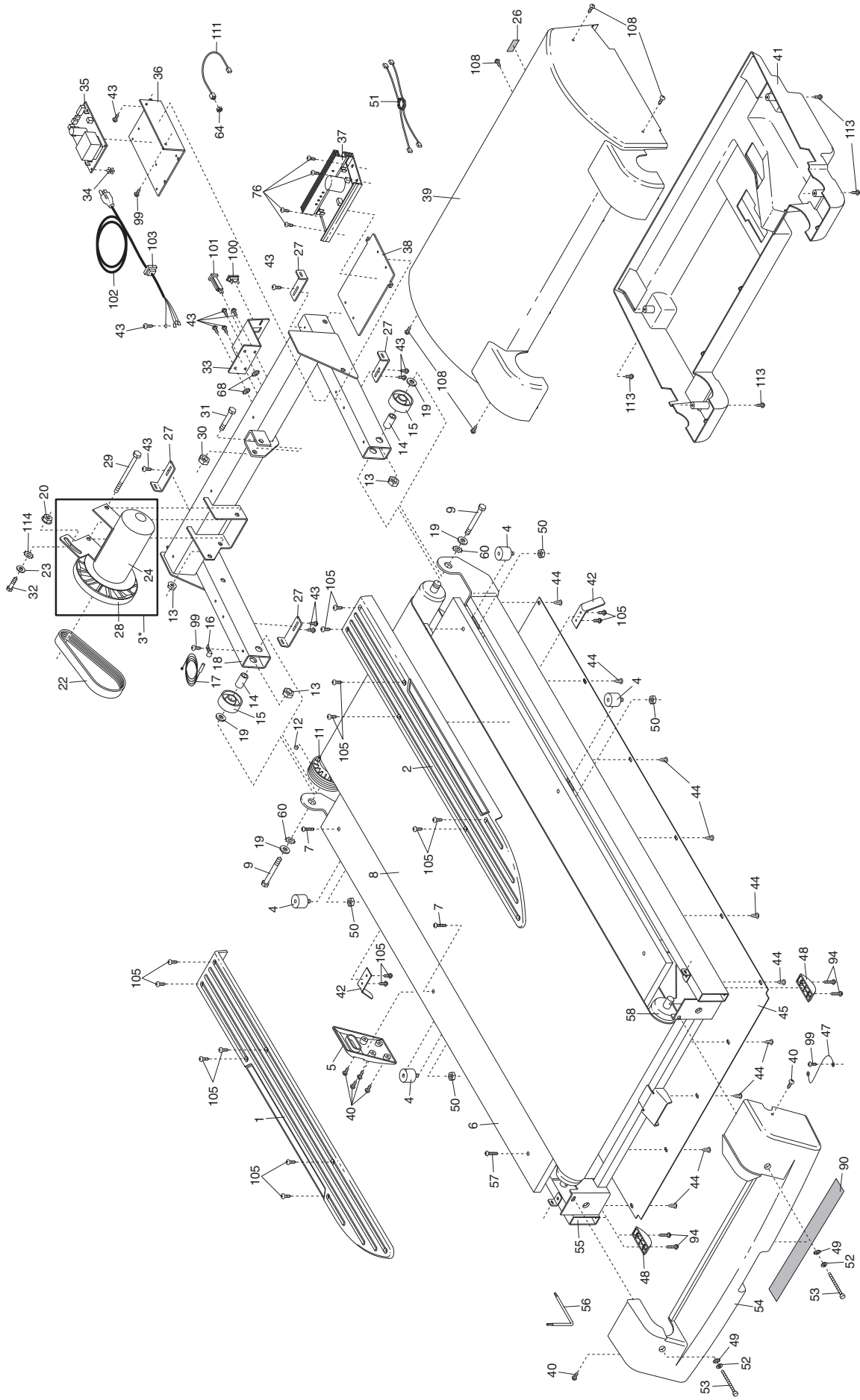

EXPLODED DRAWING—Model No. PFTL709940

R1104A

