

EXPLODED DRAWING—Model No. PFTL721040

R1104A

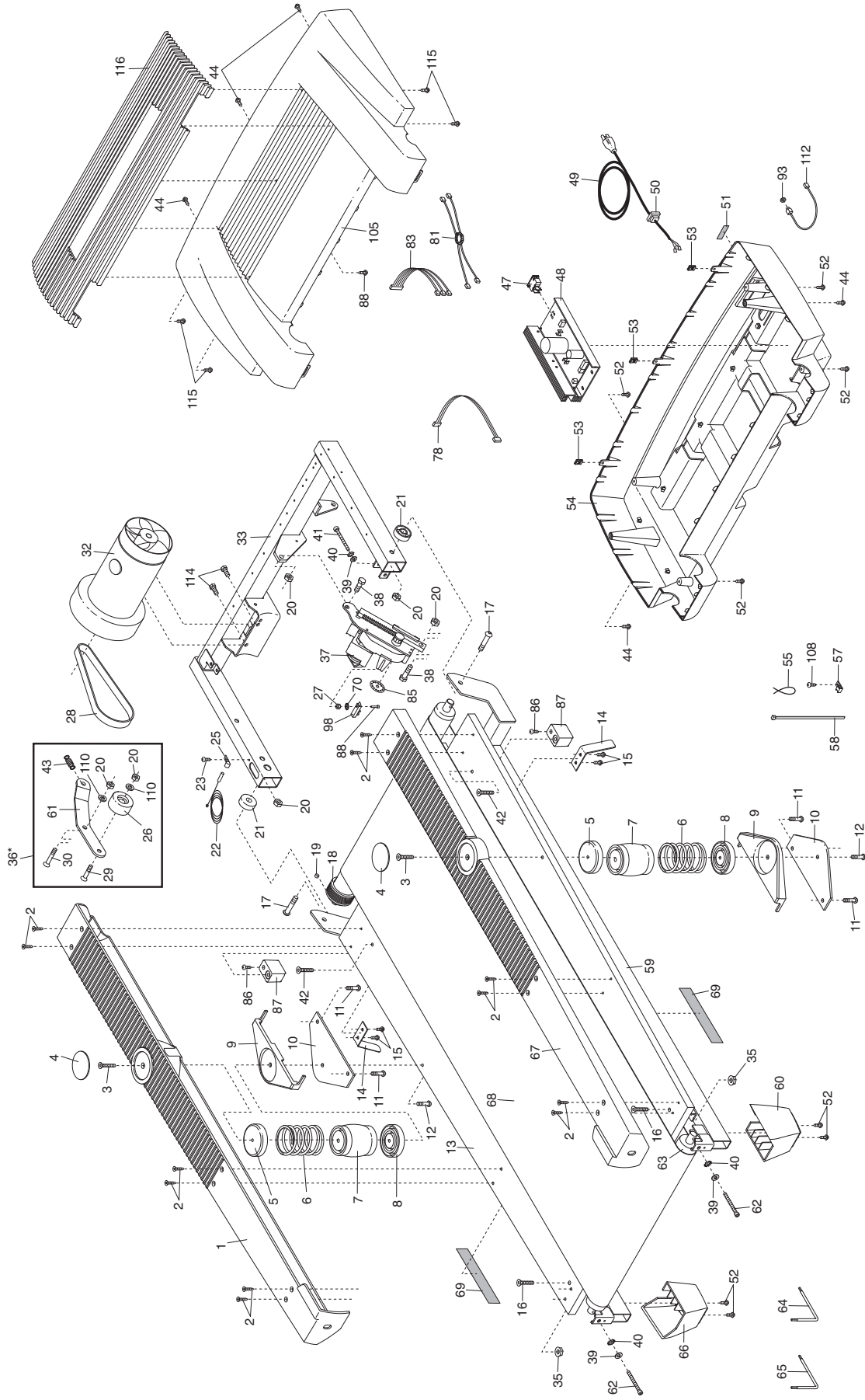

EXPLODED DRAWING—Model No. PFTL721040

R1104A

