

EXPLODED DRAWING—Model No. PFTL72572

R0398A

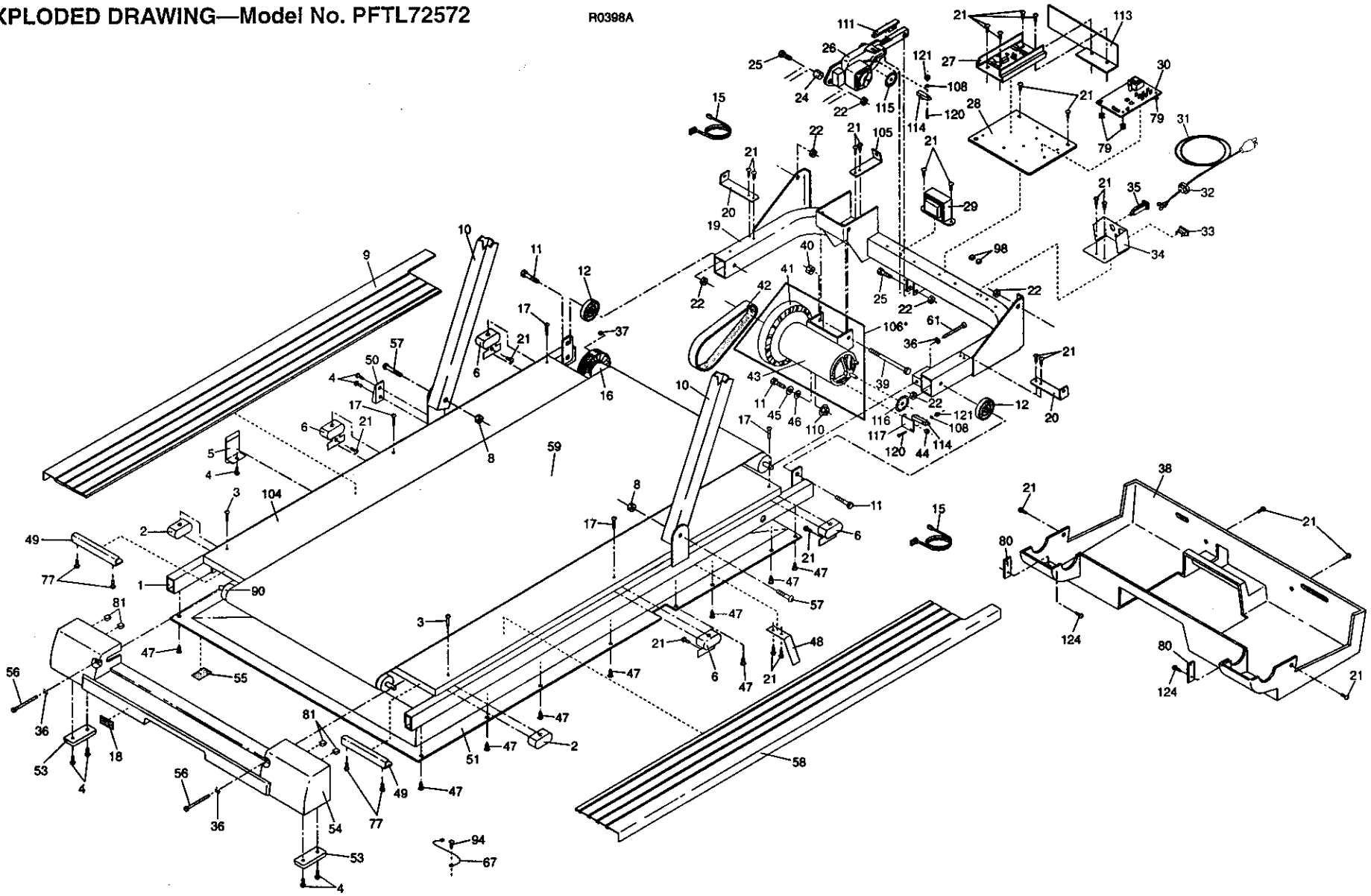

EXPLODED DRAWING—Model No. PFTL72572

R0398A

