

EXPLODED DRAWING A—Model No. PFTL72707.2

R0409A

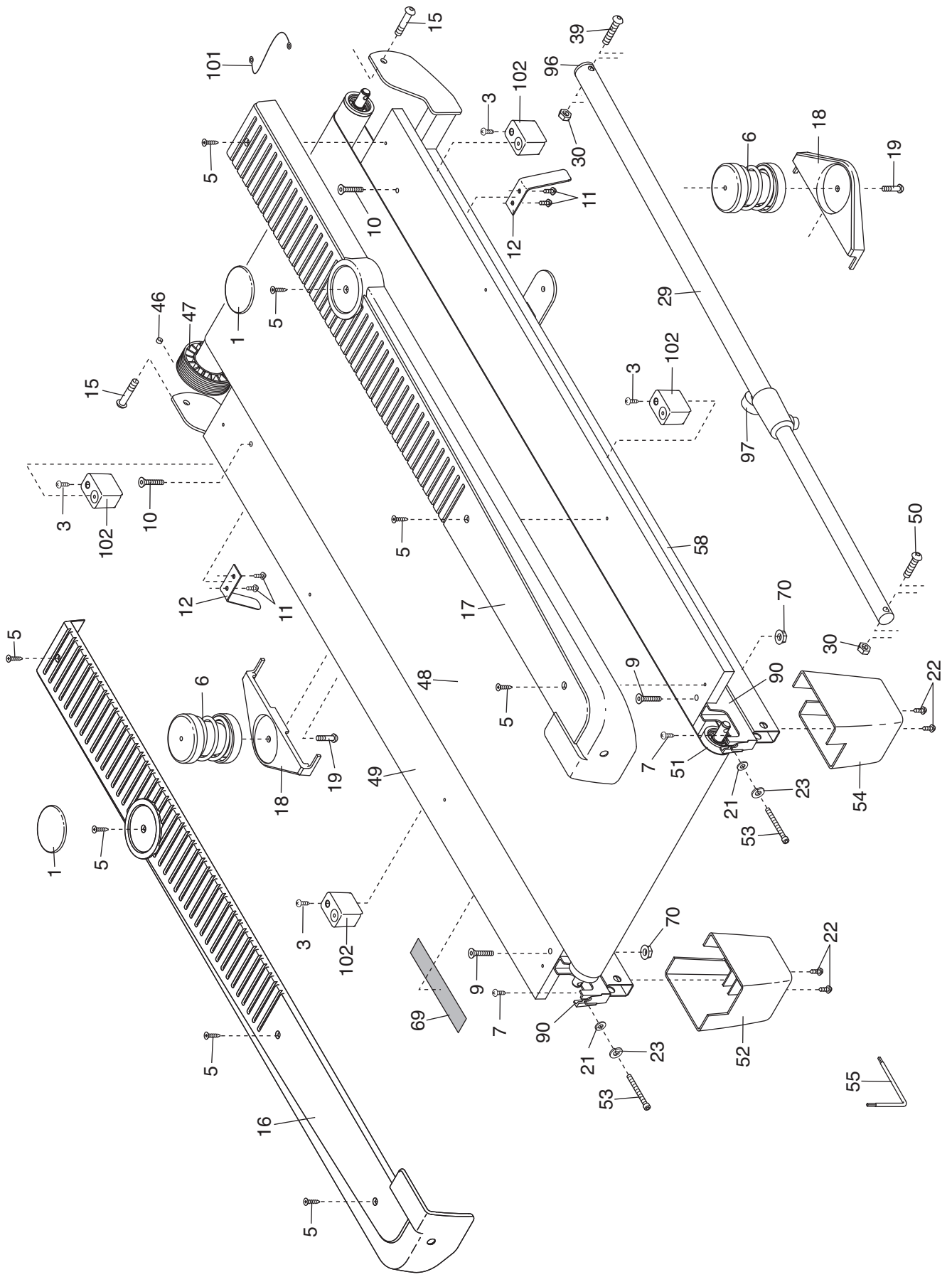

EXPLODED DRAWING C—Model No. PFTL72707.2

R0409A

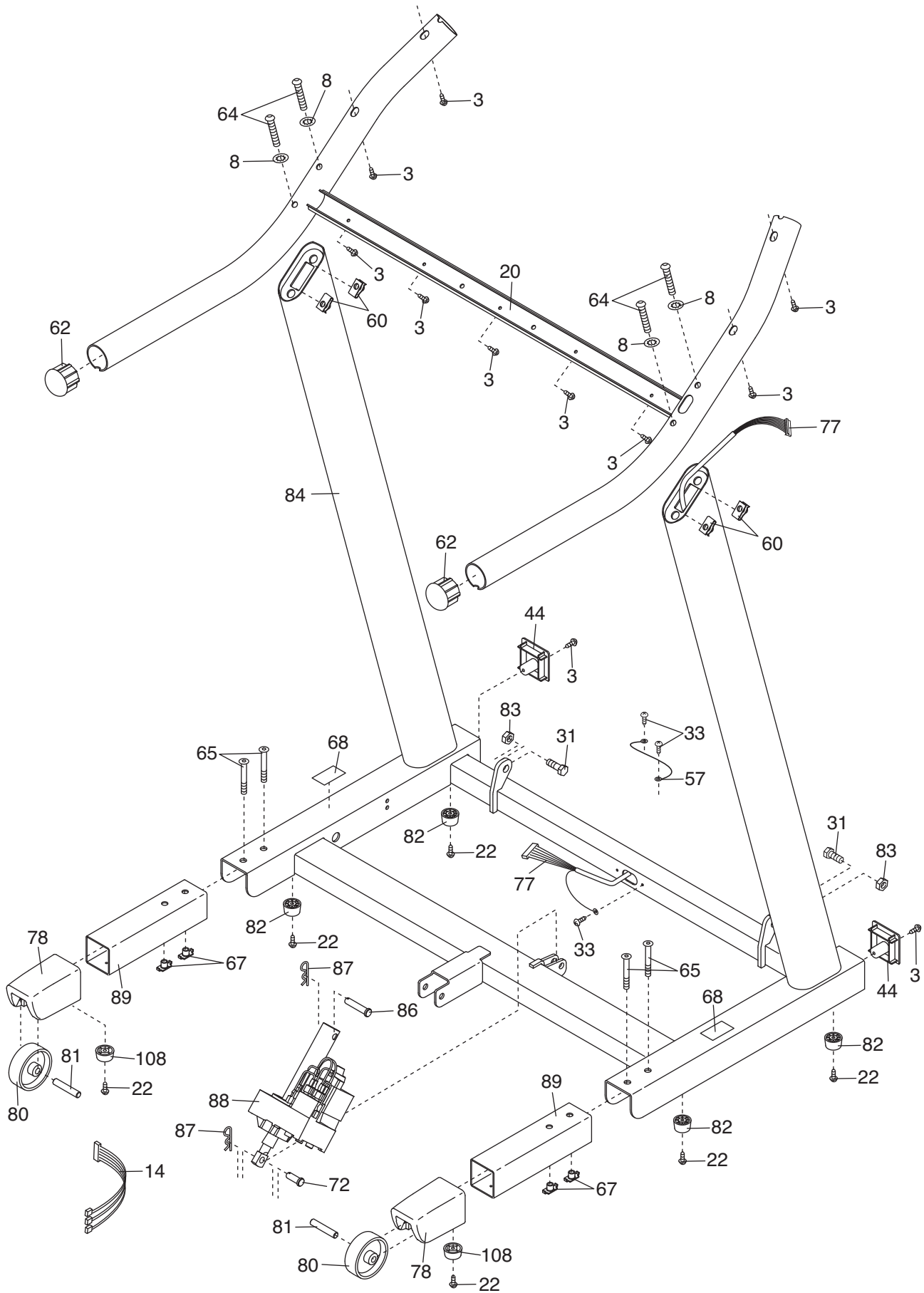

EXPLODED DRAWING D—Model No. PFTL72707.2

R0409A

