

EXPLODED DRAWING A—Model No. PFTL75909.0

R0909A

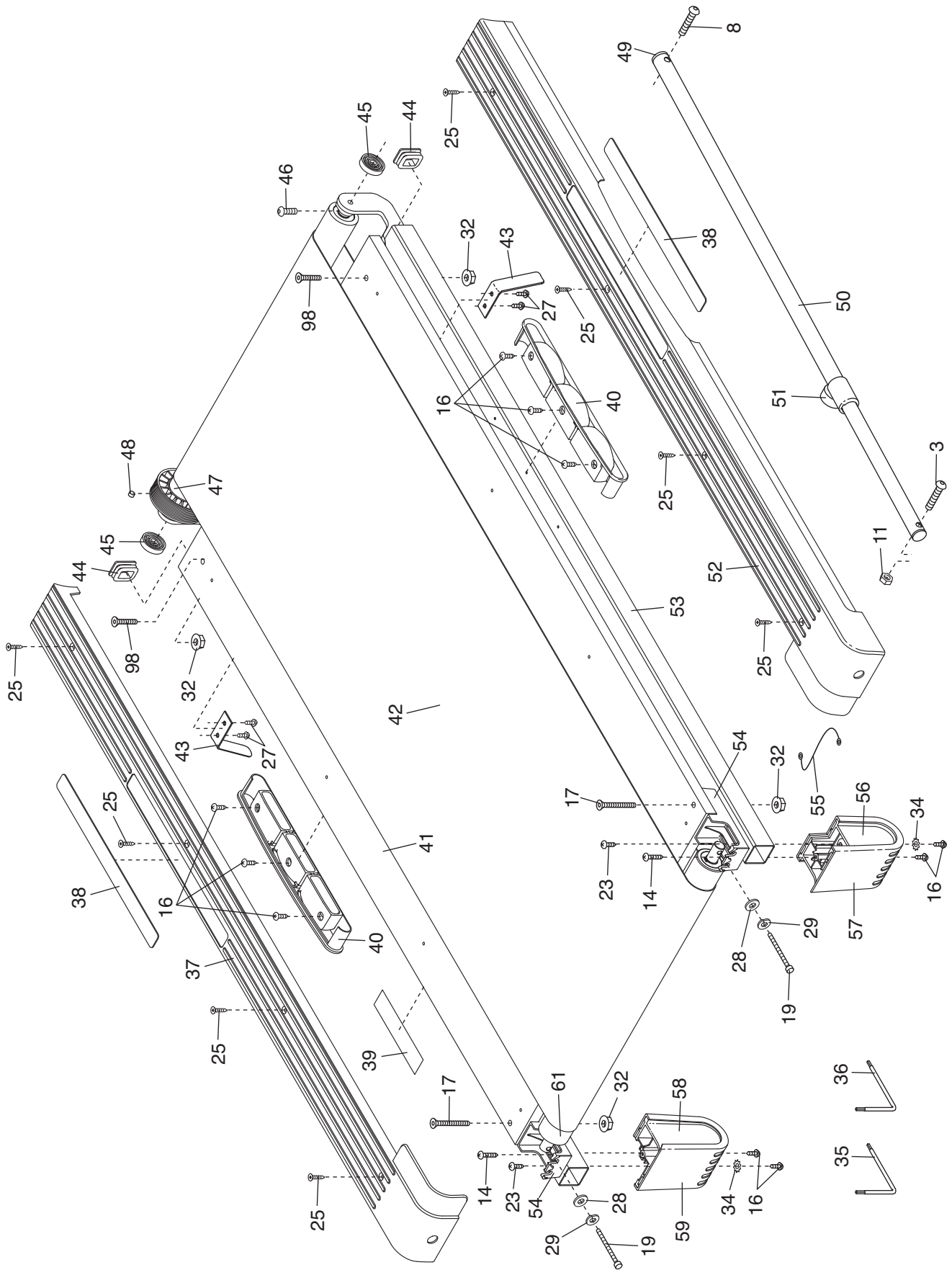

EXPLODED DRAWING B—Model No. PFTL75909.0

R0909A

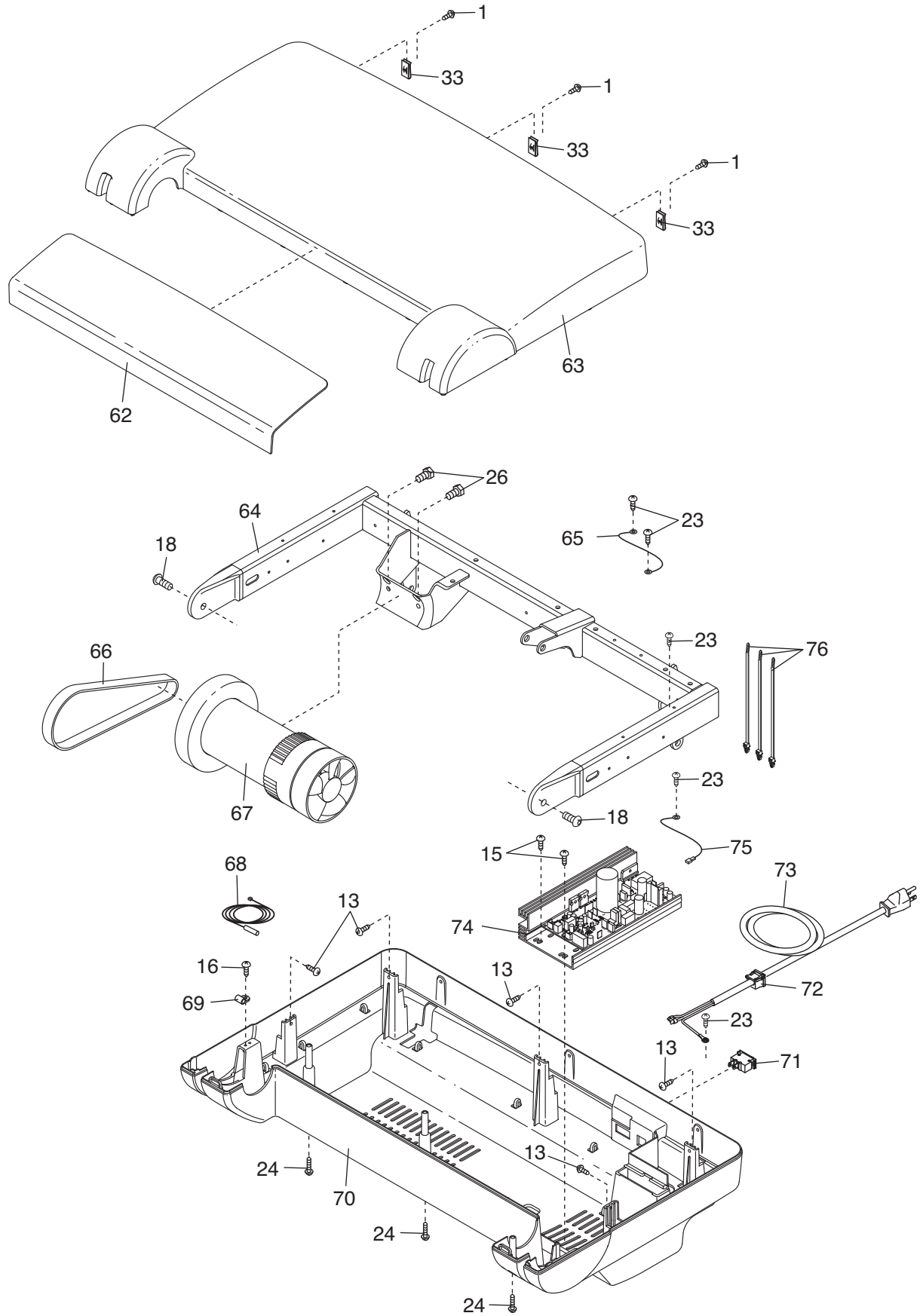

EXPLODED DRAWING C—Model No. PFTL75909.0

R0909A

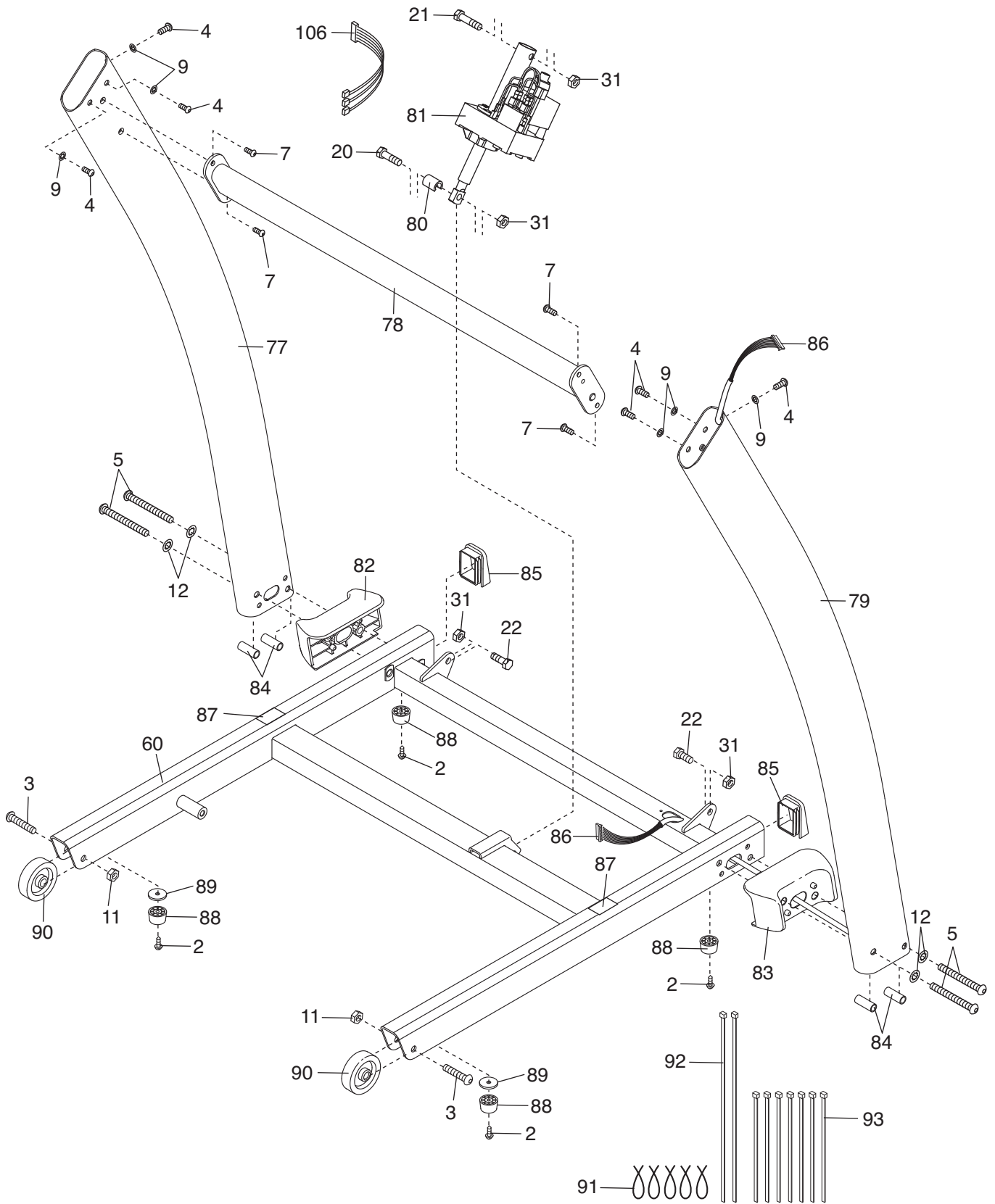

EXPLODED DRAWING D—Model No. PFTL75909.0

R0909A

