

EXPLODED DRAWING A—Model No. PFTL78508.2

R0609A

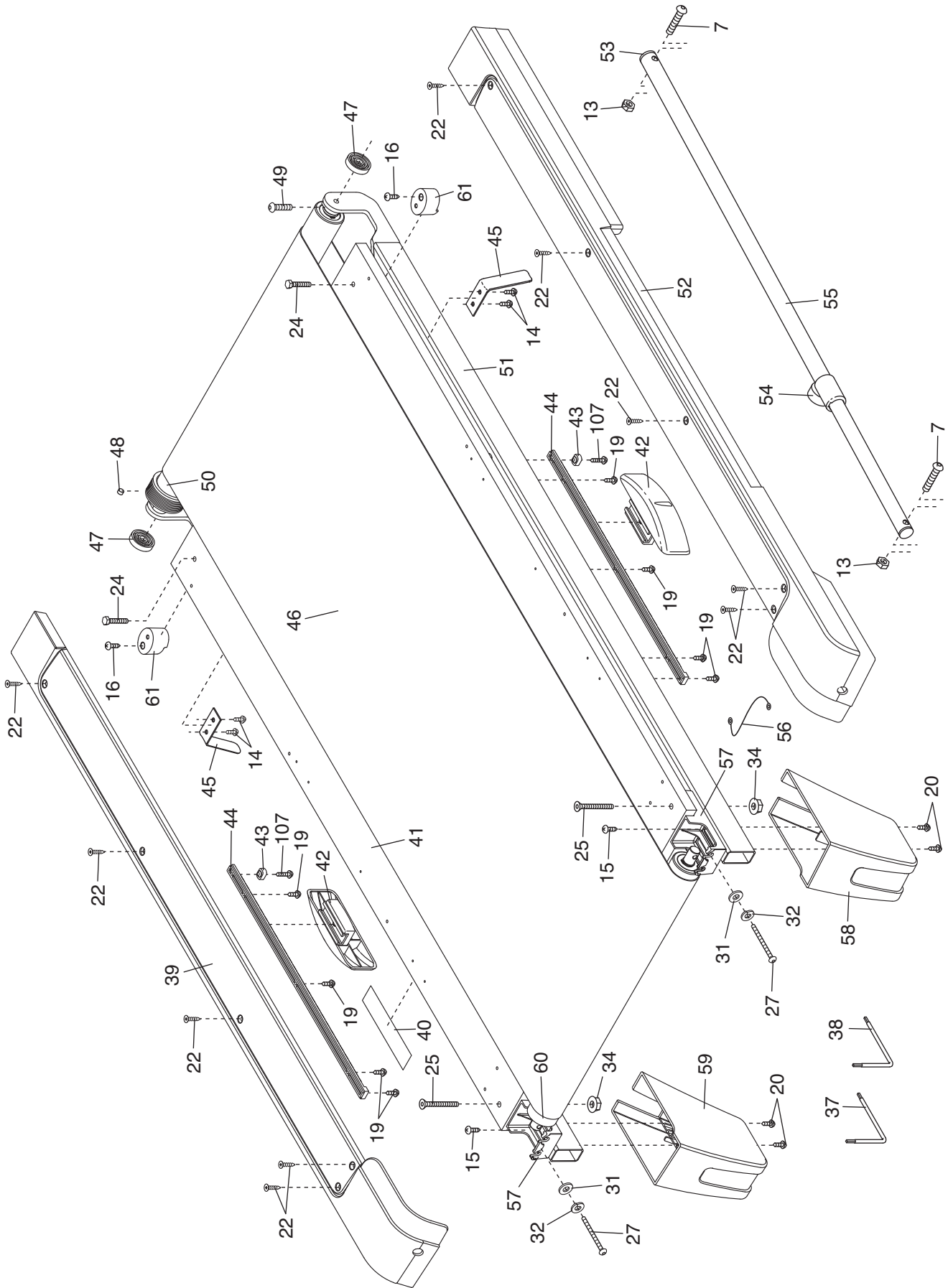

EXPLODED DRAWING B—Model No. PFTL78508.2

R0609A

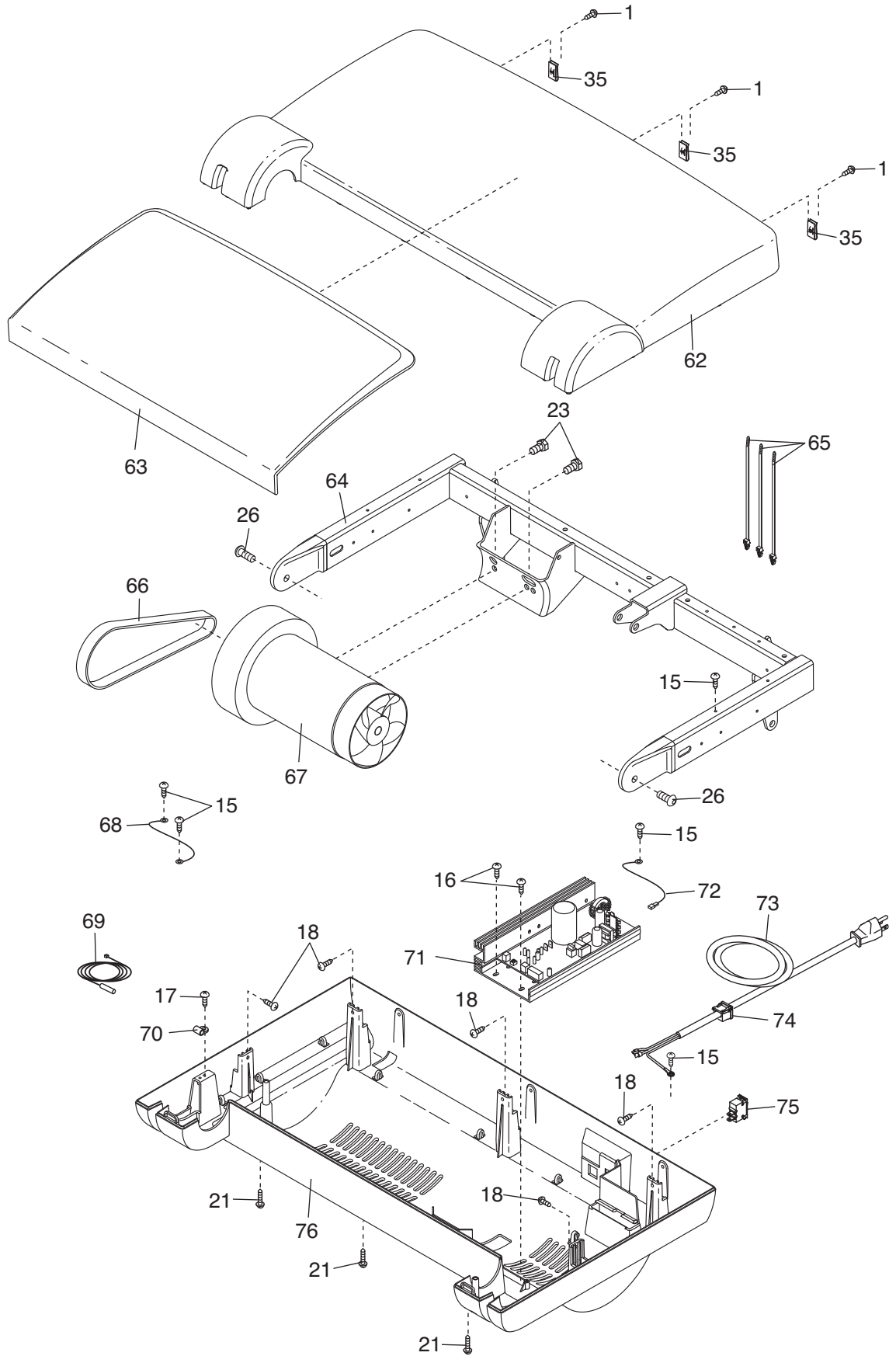

EXPLODED DRAWING D—Model No. PFTL78508.2

R0609A

