

EXPLODED DRAWING—Model No. PFTL78571

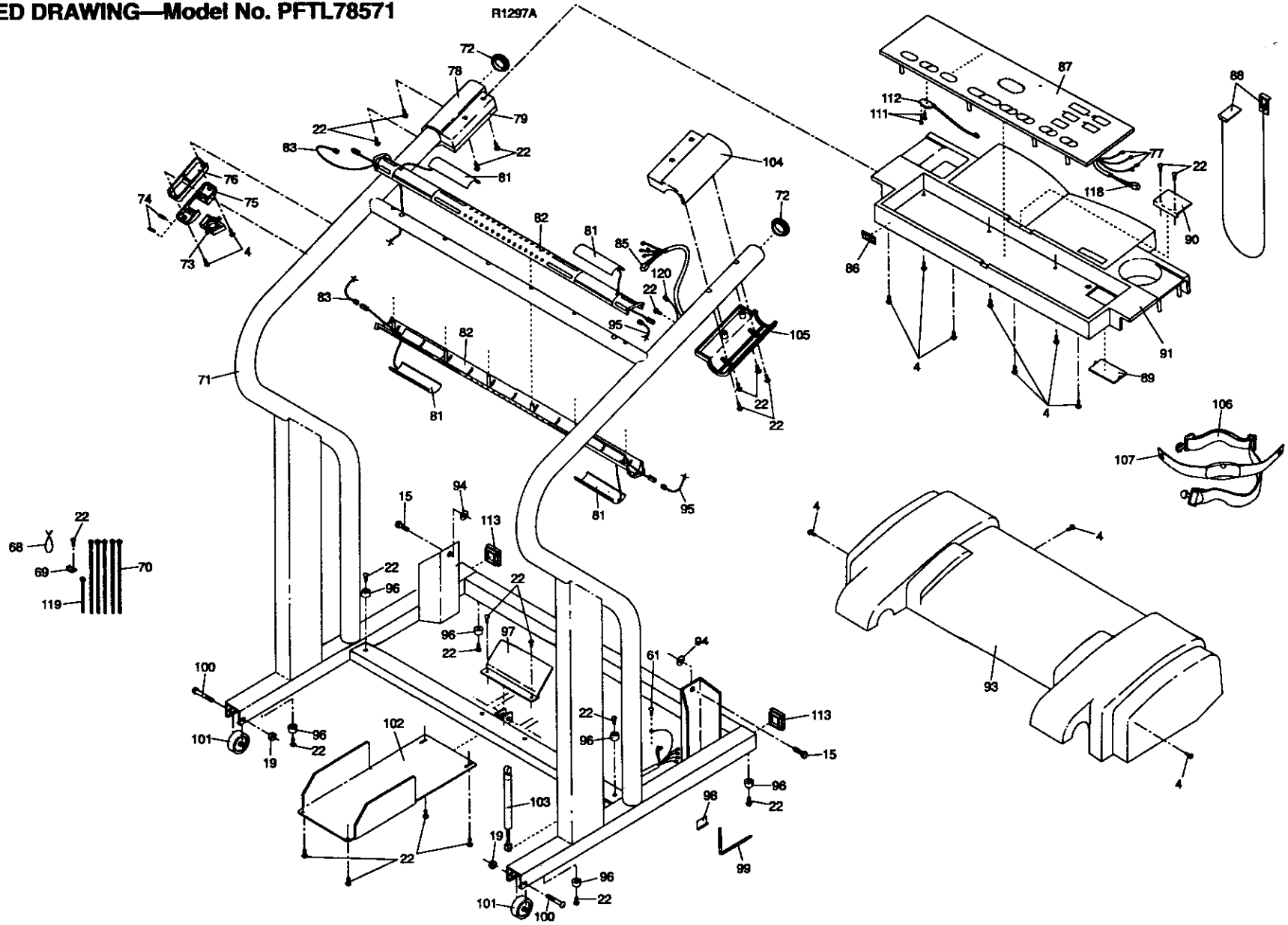

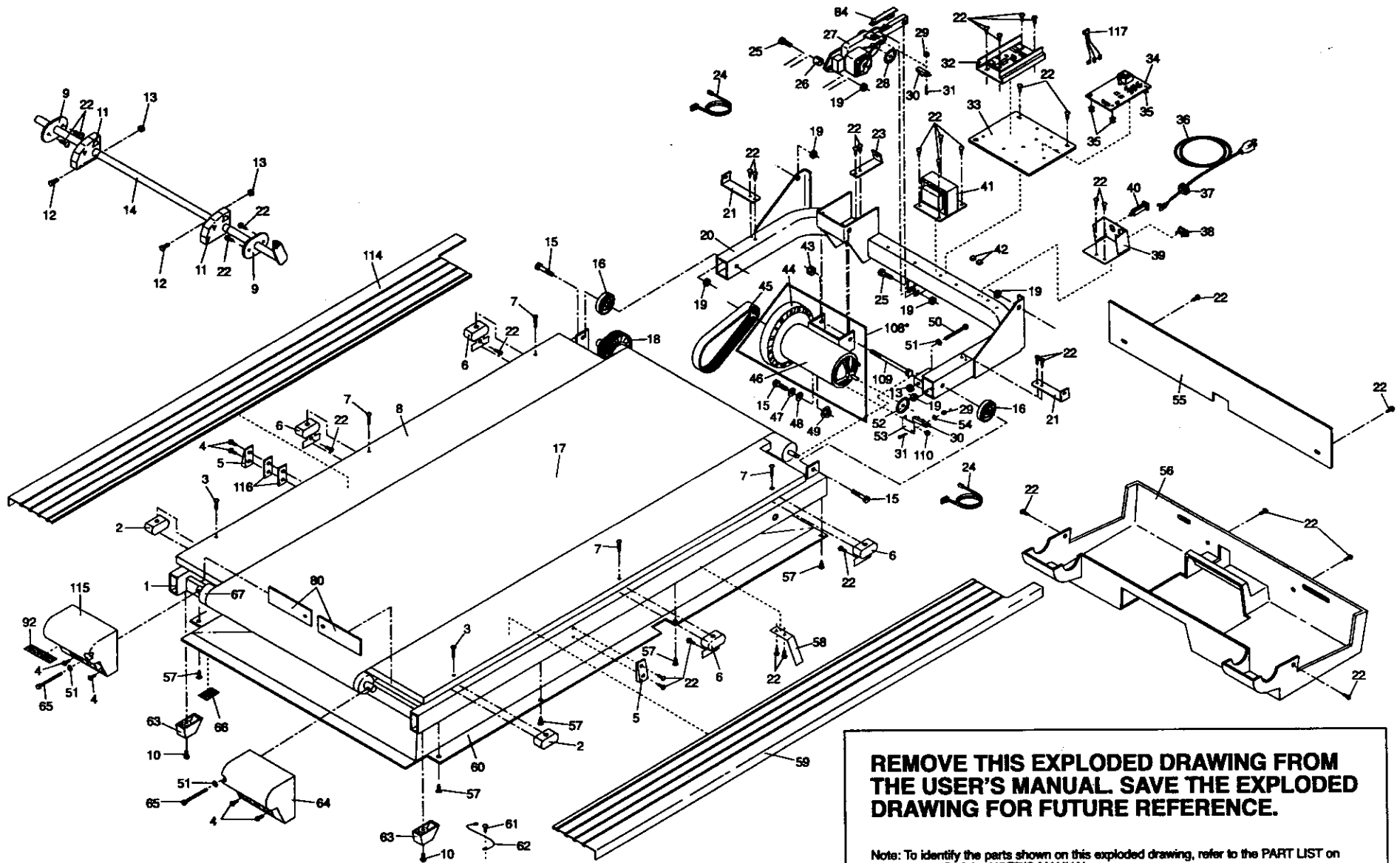

REMOVE THIS EXPLODED DRAWING FROM THE USER'S MANUAL. SAVE THE EXPLODED DRAWING FOR FUTURE REFERENCE.

Note: To identify the parts shown on this exploded drawing, refer to the PART LIST on page 15 of the USER'S MANUAL.