

EXPLODED DRAWING A—Model No. PFTL79007.0

R0907A

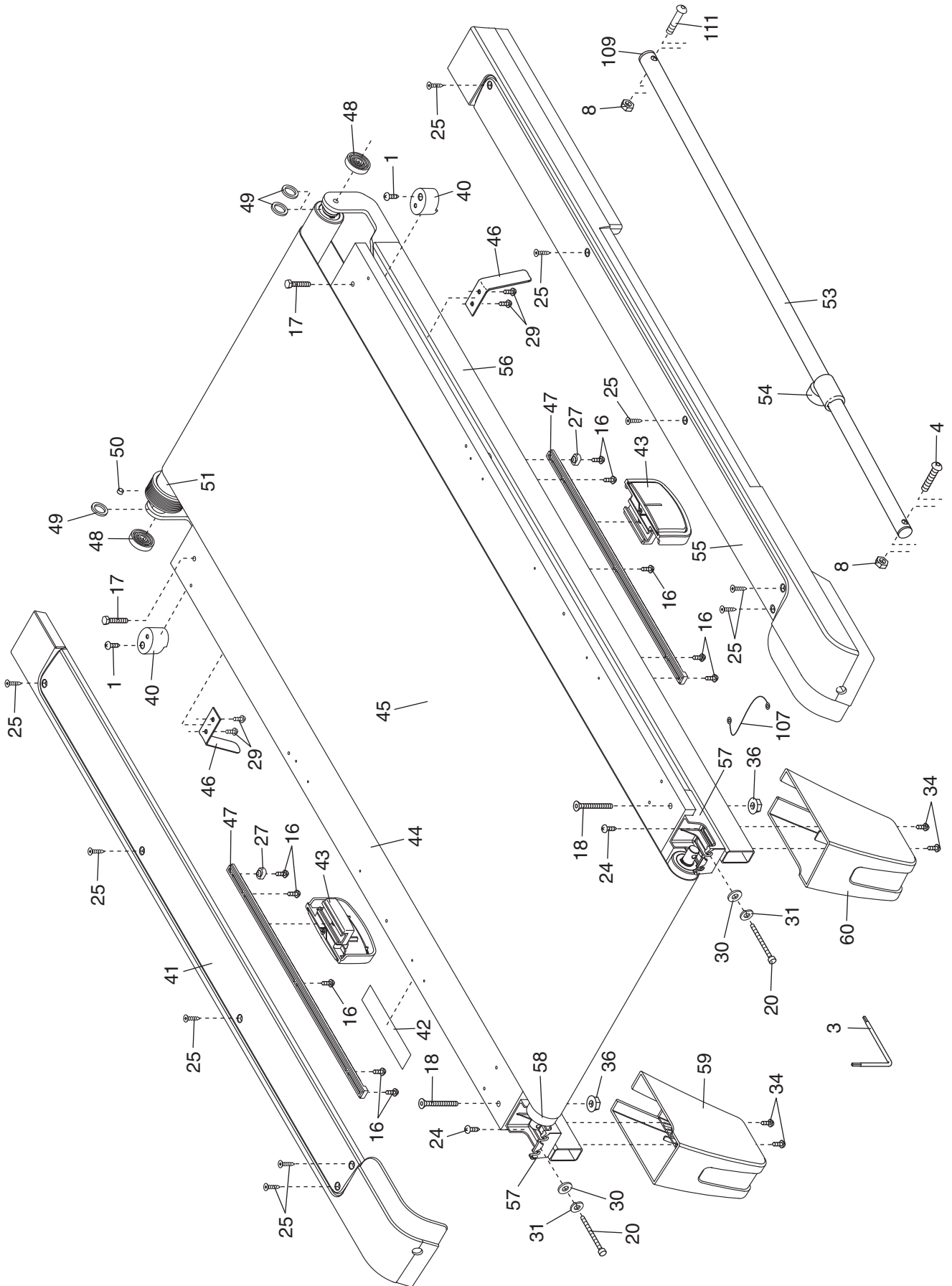

EXPLODED DRAWING B—Model No. PFTL79007.0

R0907A

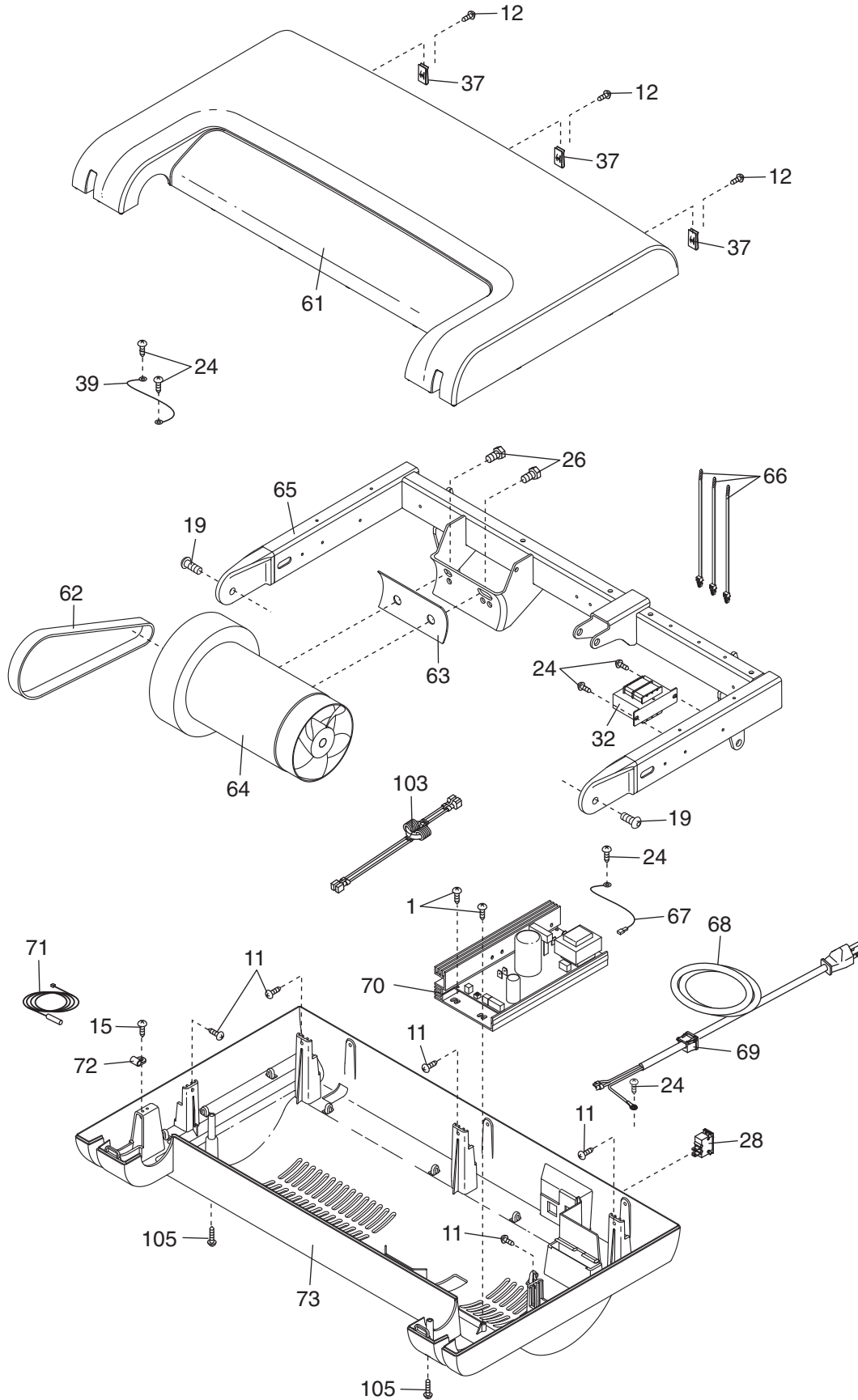

EXPLODED DRAWING C—Model No. PFTL79007.0

R0907A

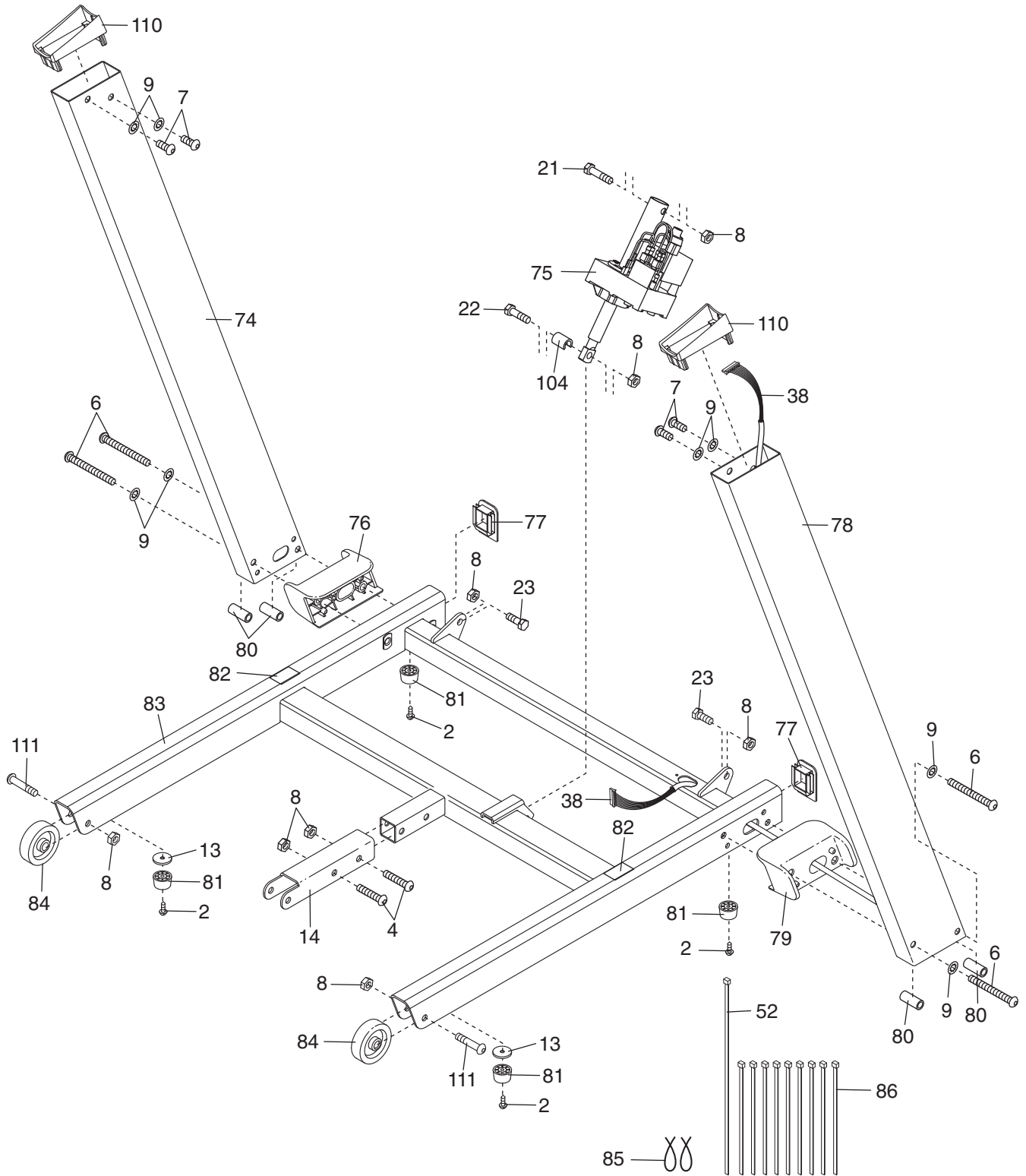

EXPLODED DRAWING D—Model No. PFTL79007.0

R0907A

