

EXPLODED DRAWING A—Model No. PFTL79007.1

R1107A

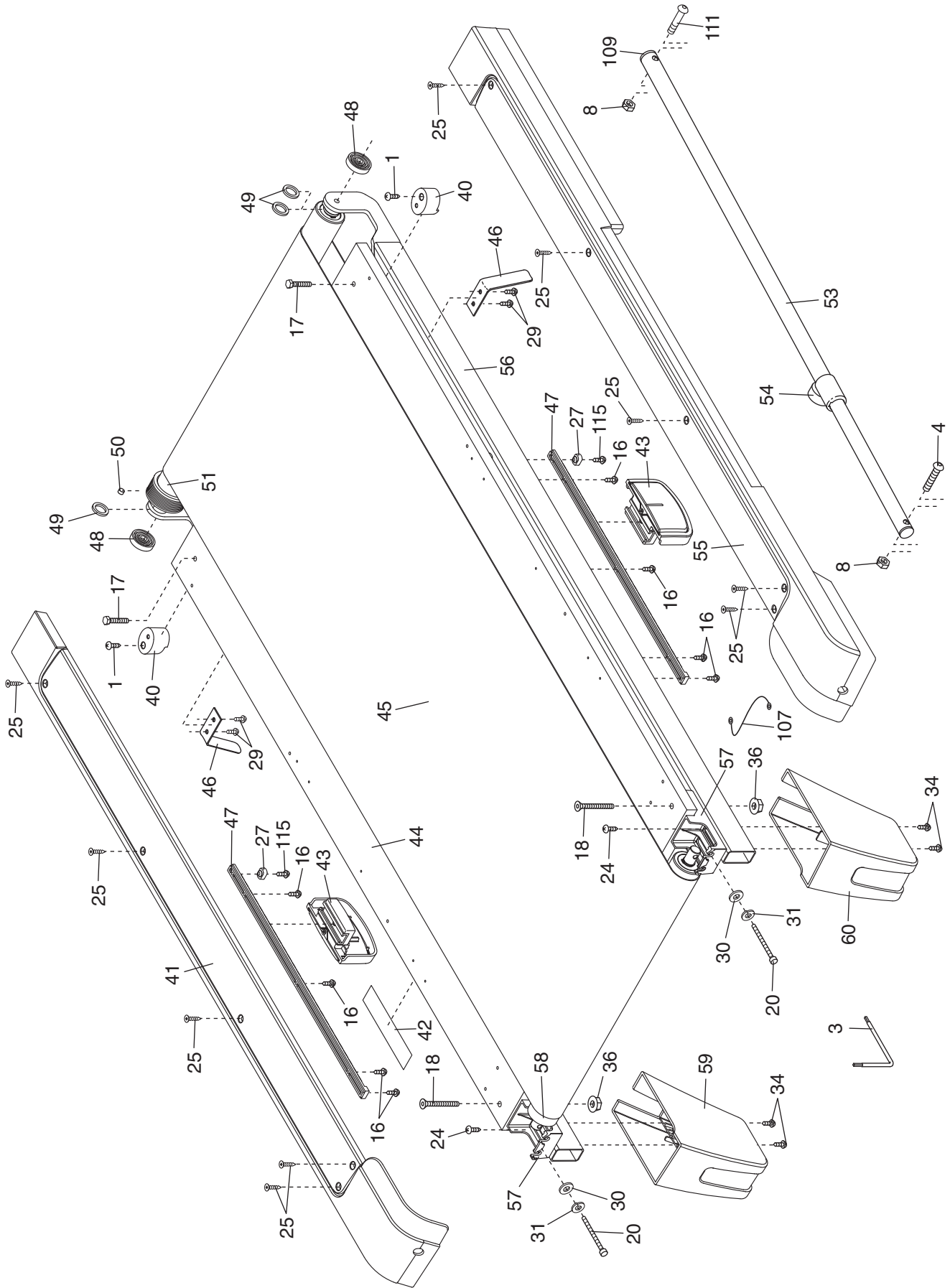

EXPLODED DRAWING B—Model No. PFTL79007.1

R1107A

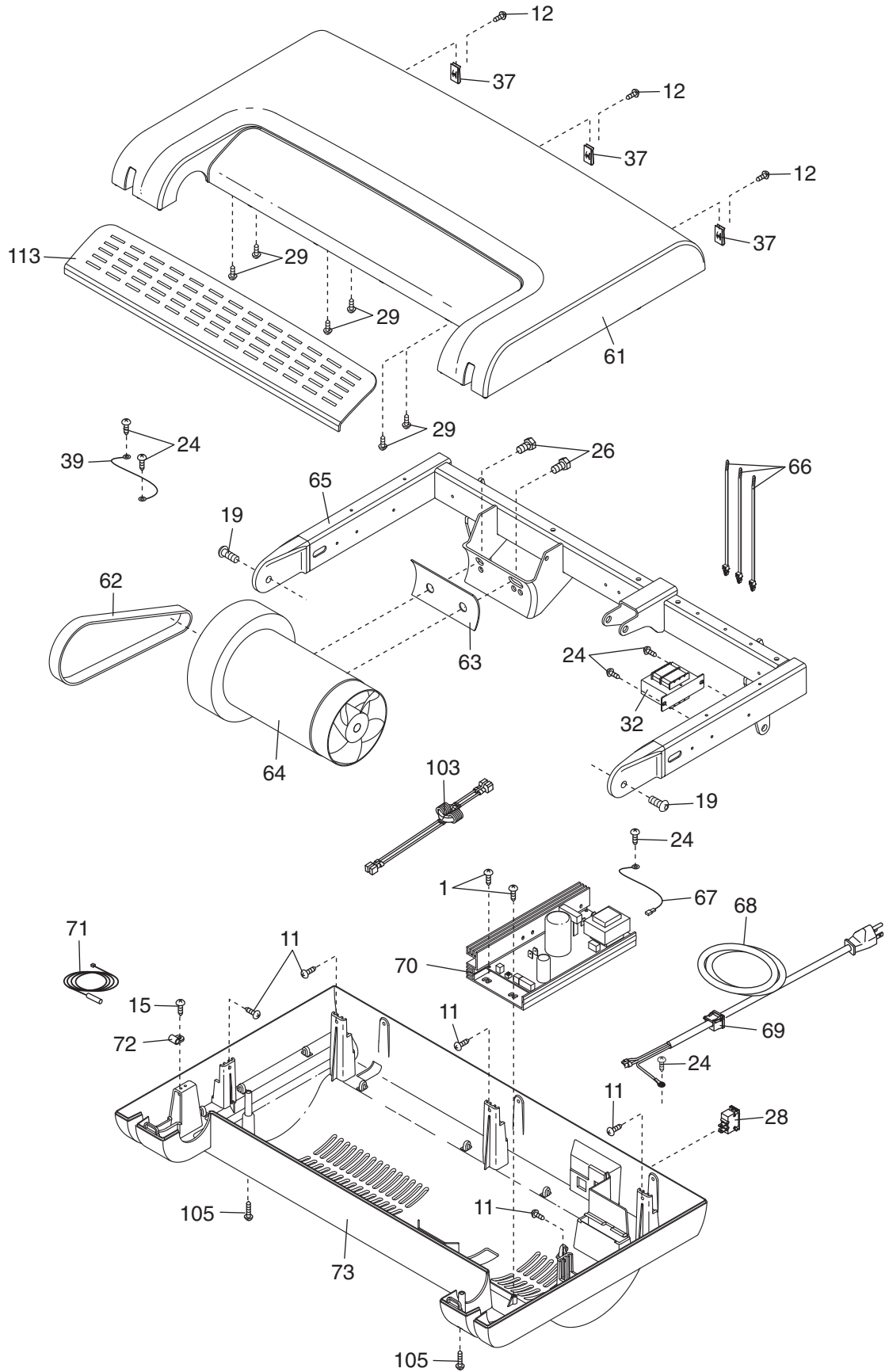

EXPLODED DRAWING C—Model No. PFTL79007.1

R1107A

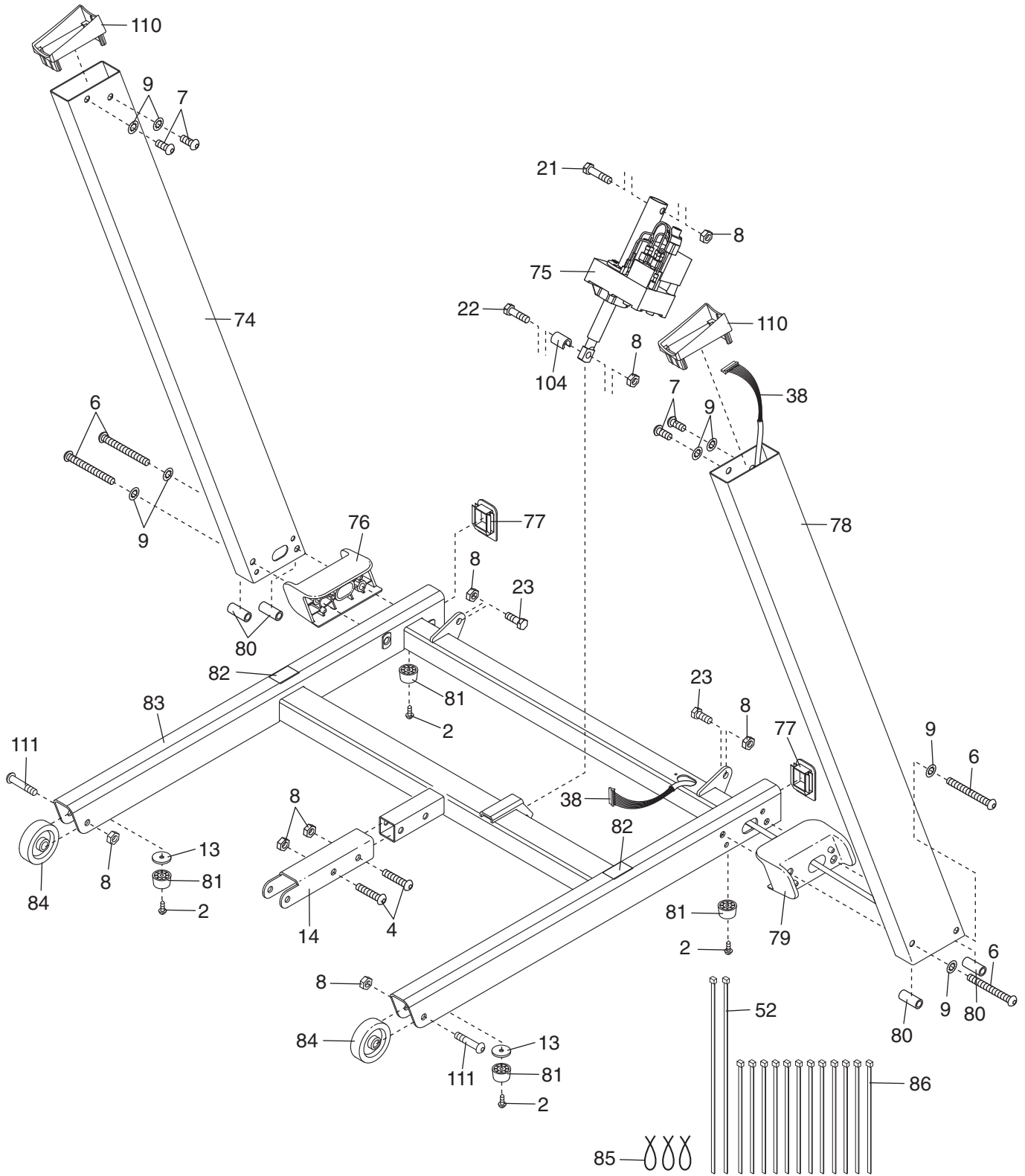

EXPLODED DRAWING D—Model No. PFTL79007.1

R1107A

