

EXPLODED DRAWING—Model No. PFTL79023

R1104A

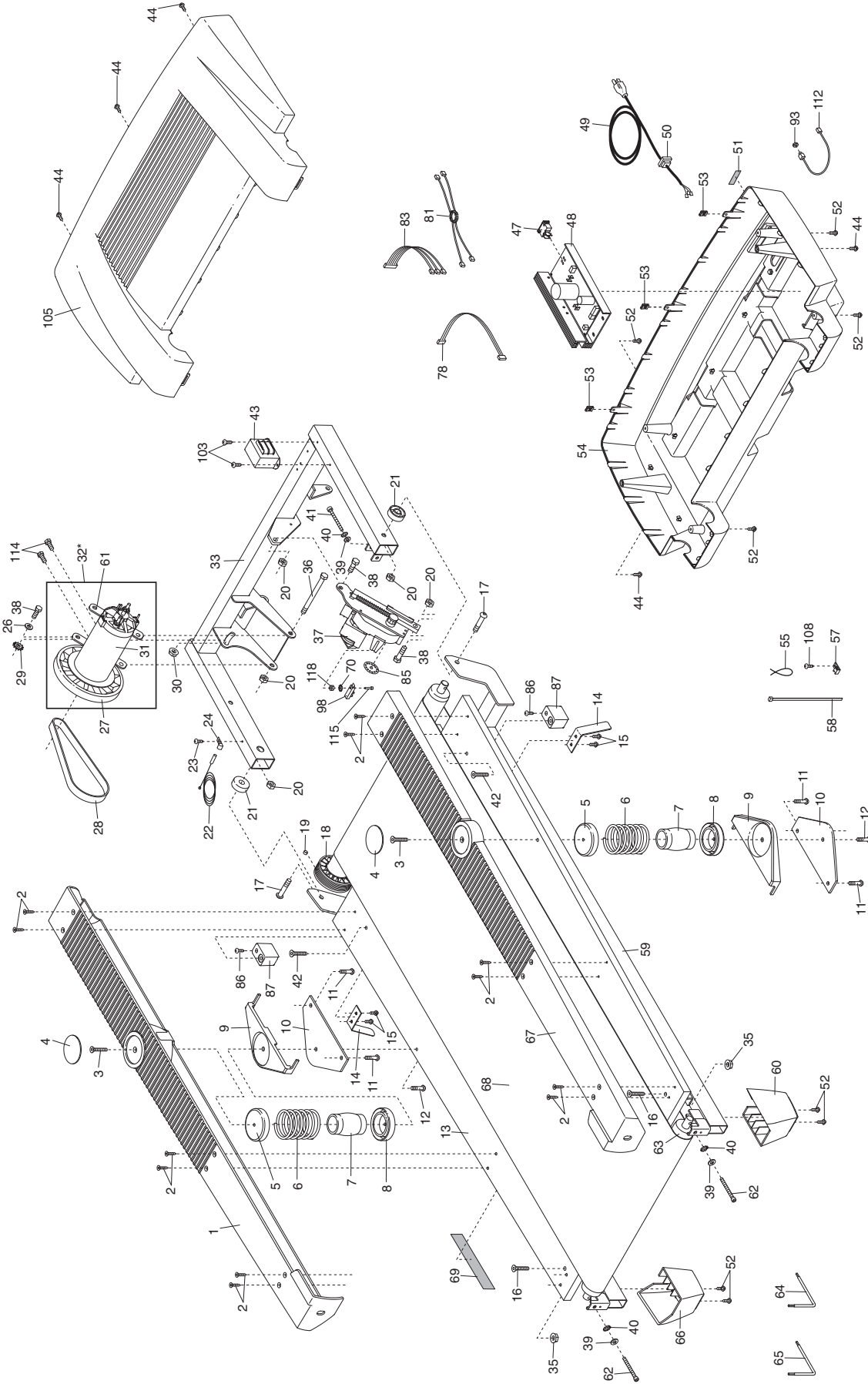

EXPLODED DRAWING—Model No. PFTL79023

R1104A

