

EXPLODED DRAWING—Model No. PFTL79021

R0703A

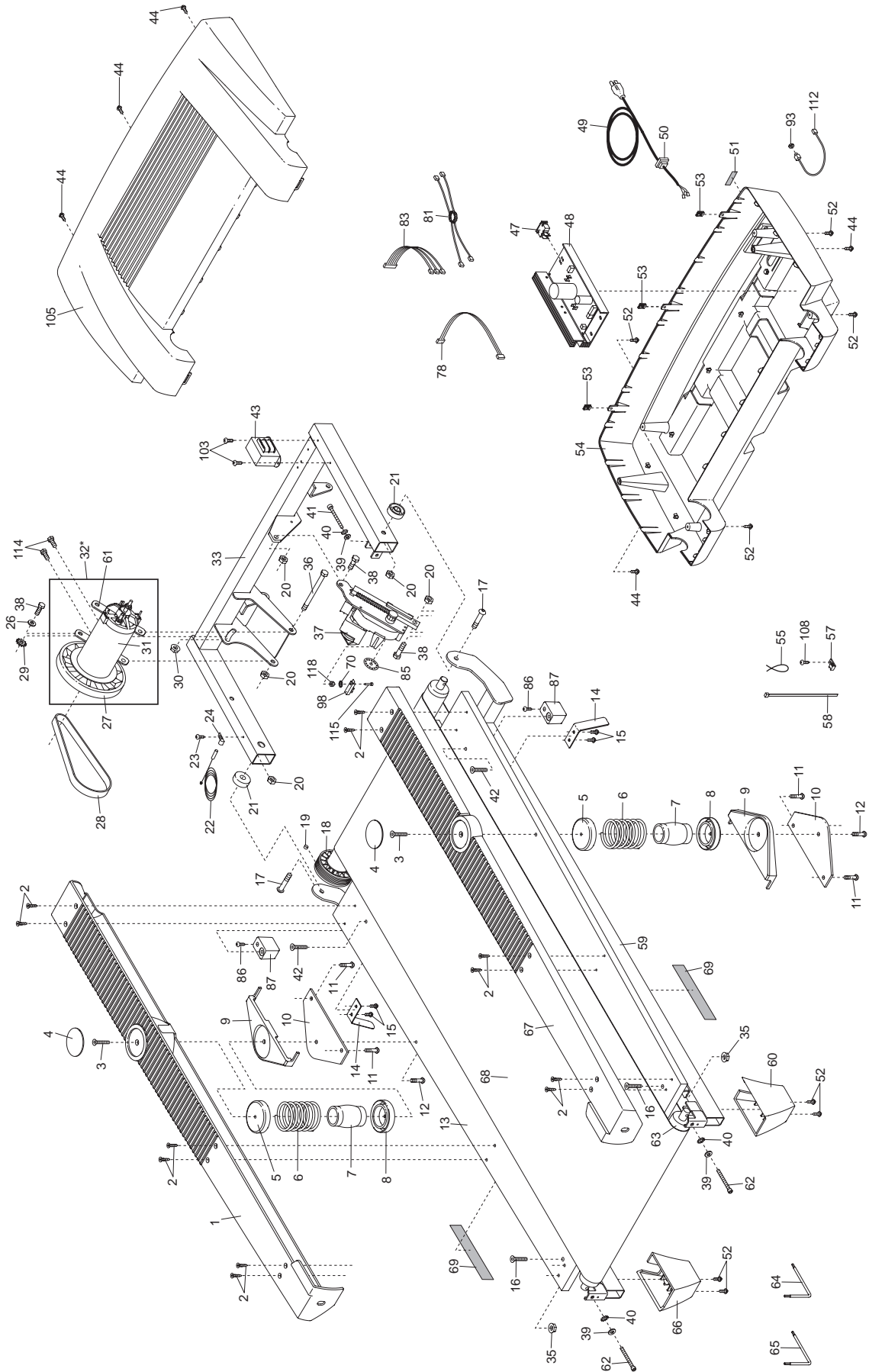

EXPLODED DRAWING—Model No. PFTL79021

R0703A

