

EXPLODED DRAWING—Model No. PFTL79102

R0803A

To identify the parts shown on this exploded drawing, refer to the PART LIST on page 23 of the USER'S MANUAL.

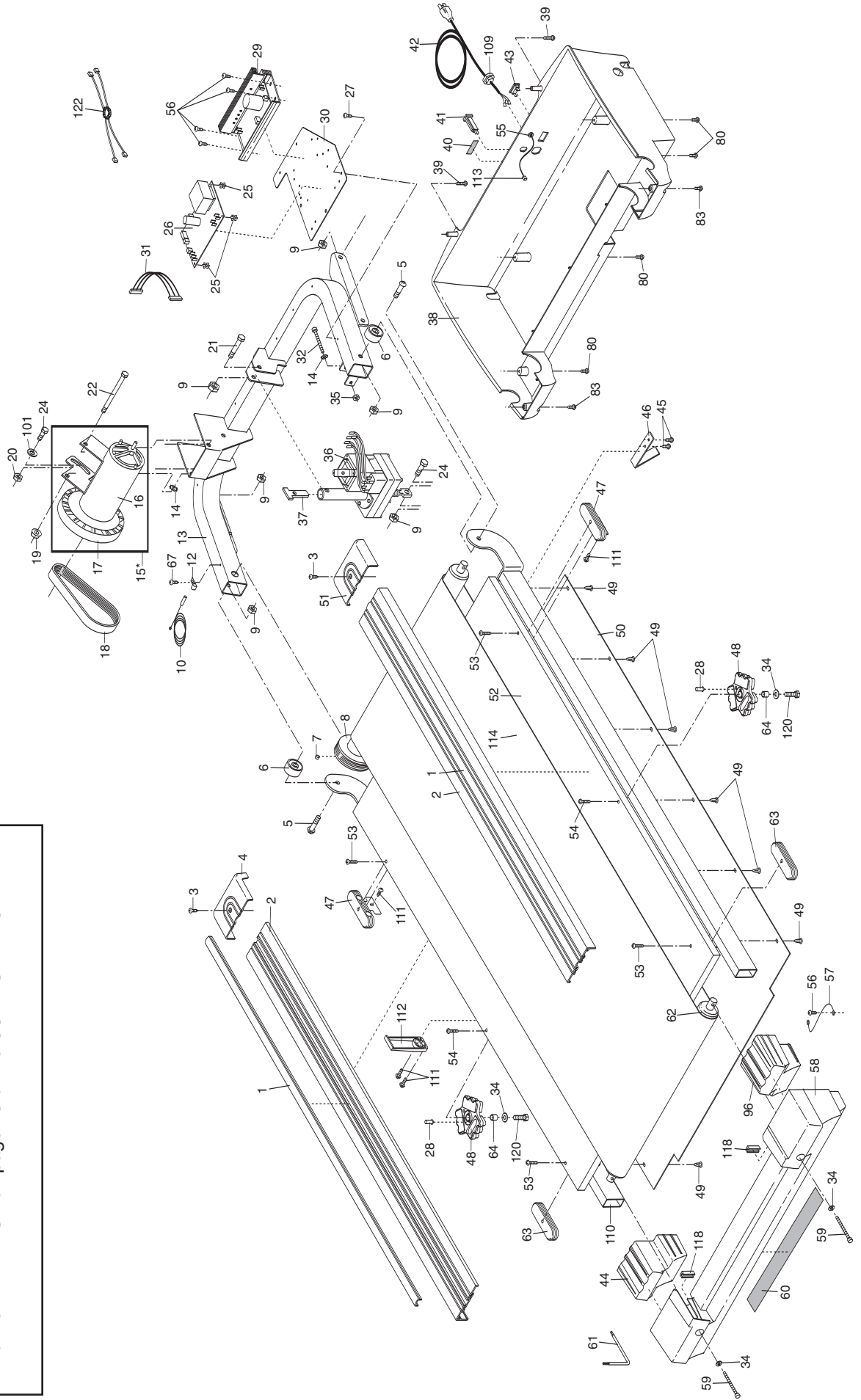

EXPLODED DRAWING—Model No. PFTL79102

R0803A

