

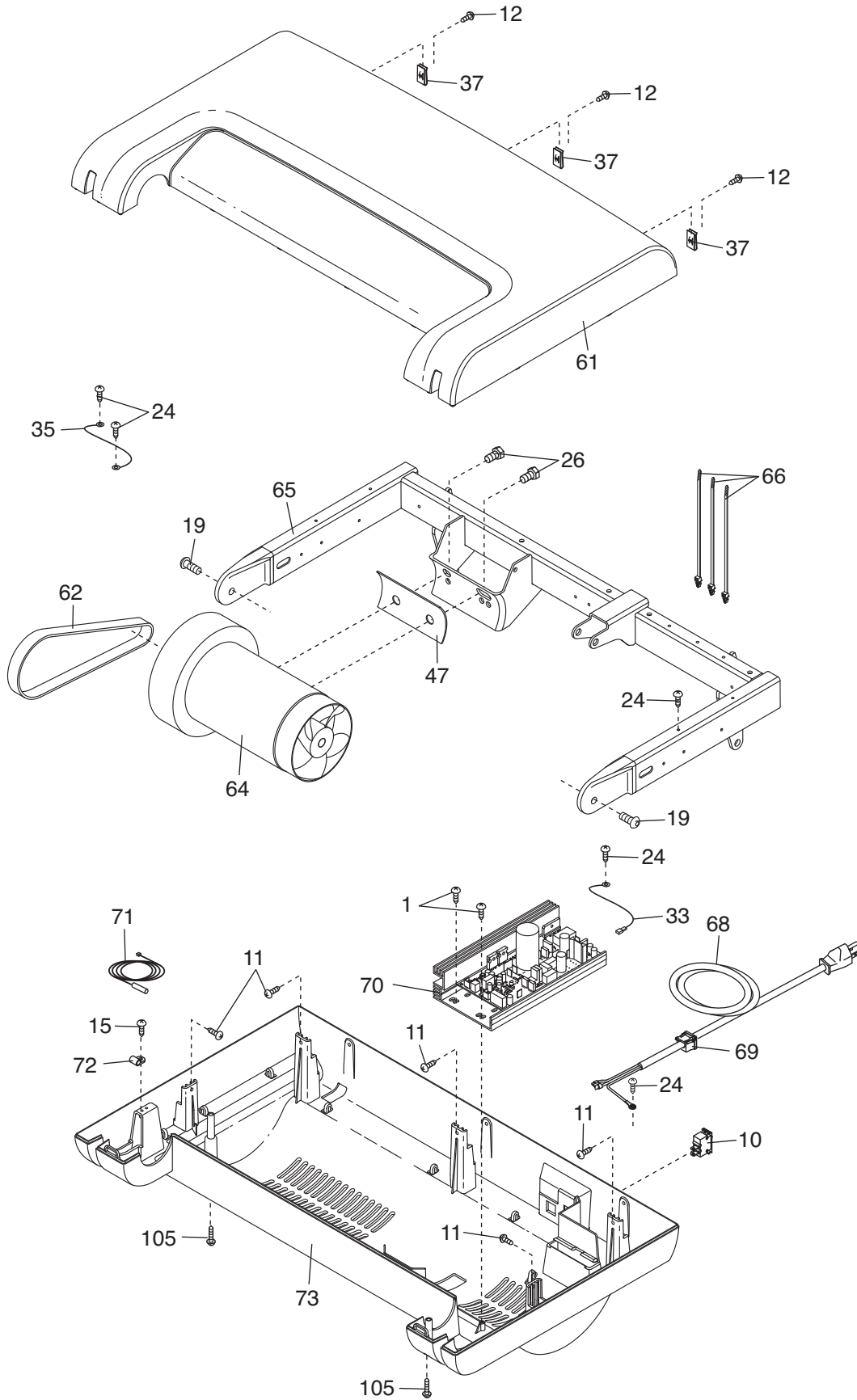

# EXPLODED DRAWING B—Model No. PFTL79108.0

R0708A



# EXPLODED DRAWING C—Model No. PFTL79108.0

R0708A

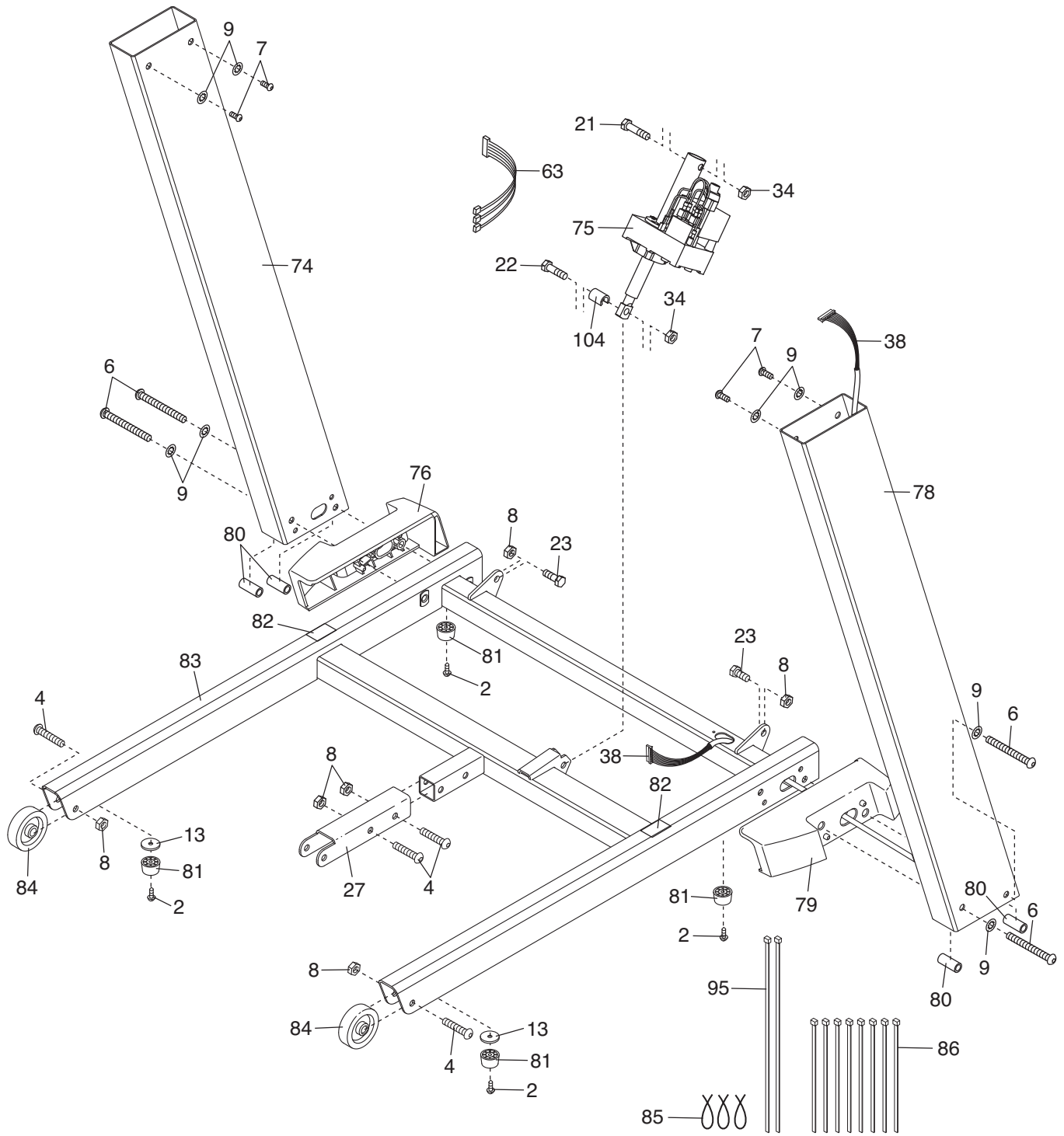

# EXPLODED DRAWING D—Model No. PFTL79108.0

R0708A

