

EXPLODED DRAWING A

Model No. PFTL79113.2 R1116A

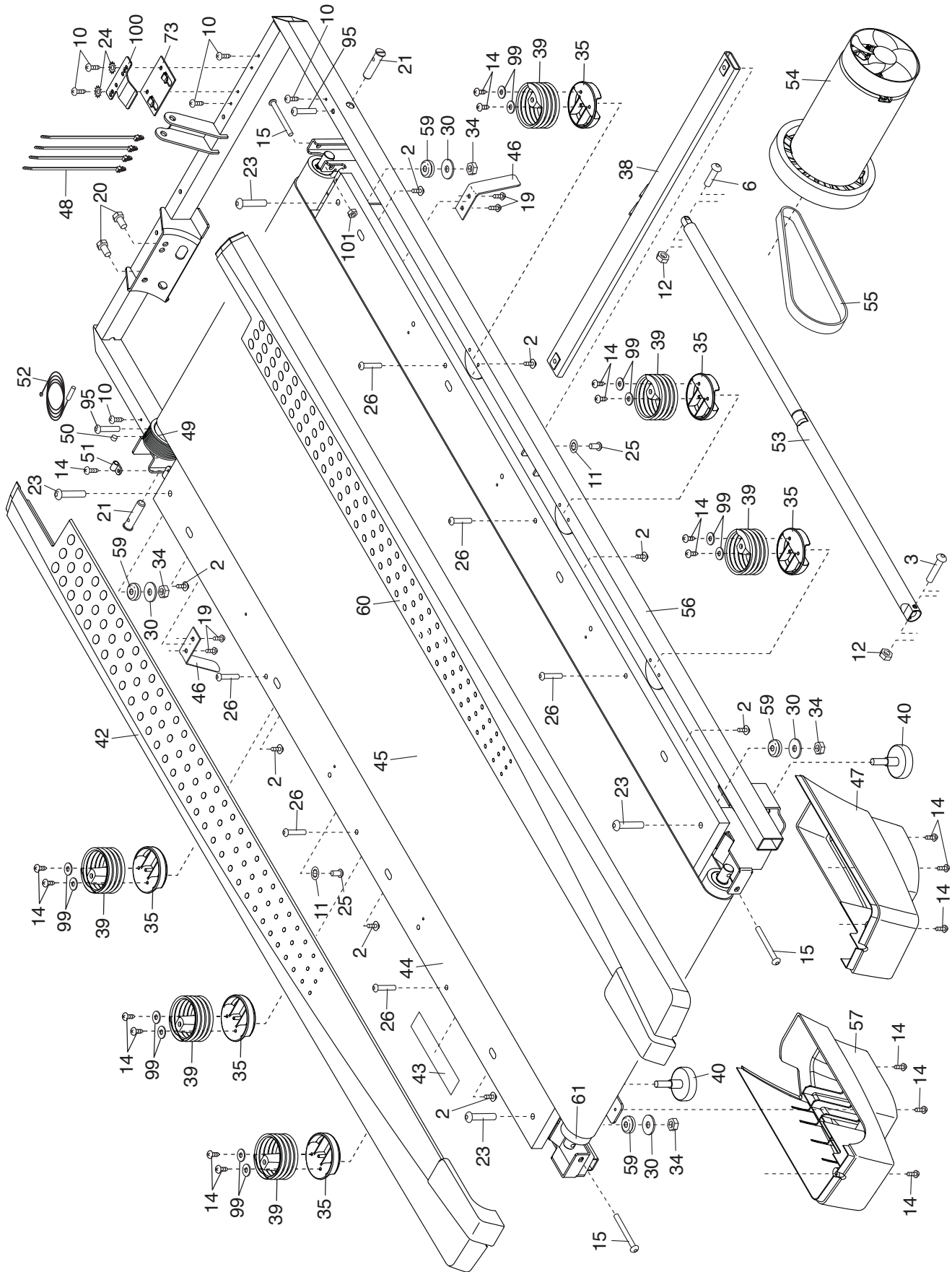

EXPLODED DRAWING B

Model No. PFTL79113.2 R1116A

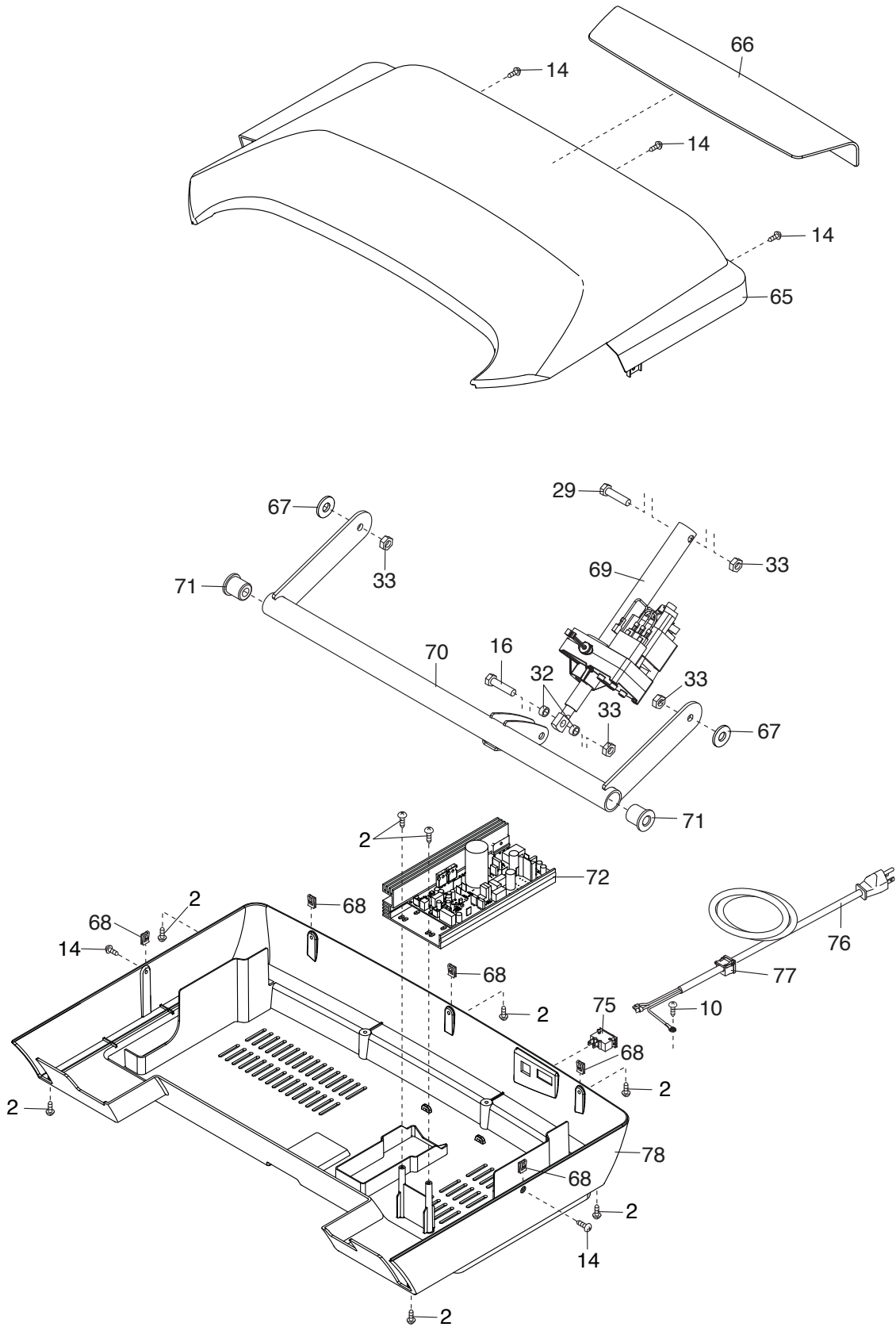

EXPLODED DRAWING C

Model No. PFTL79113.2 R1116A

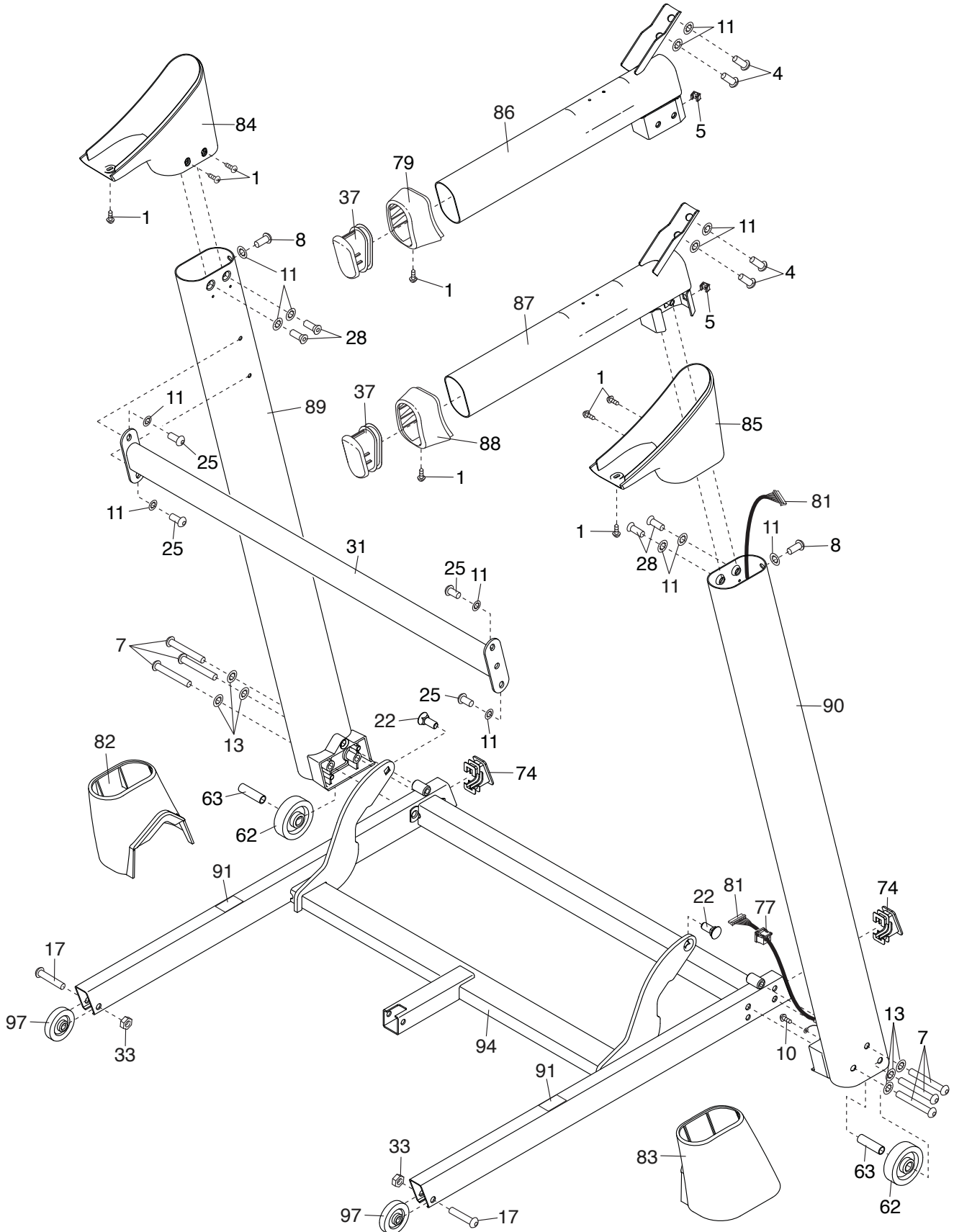

EXPLODED DRAWING D

Model No. PFTL79113.2 R1116A

