

# EXPLODED DRAWING—Model No. PFTL79192

R0100A

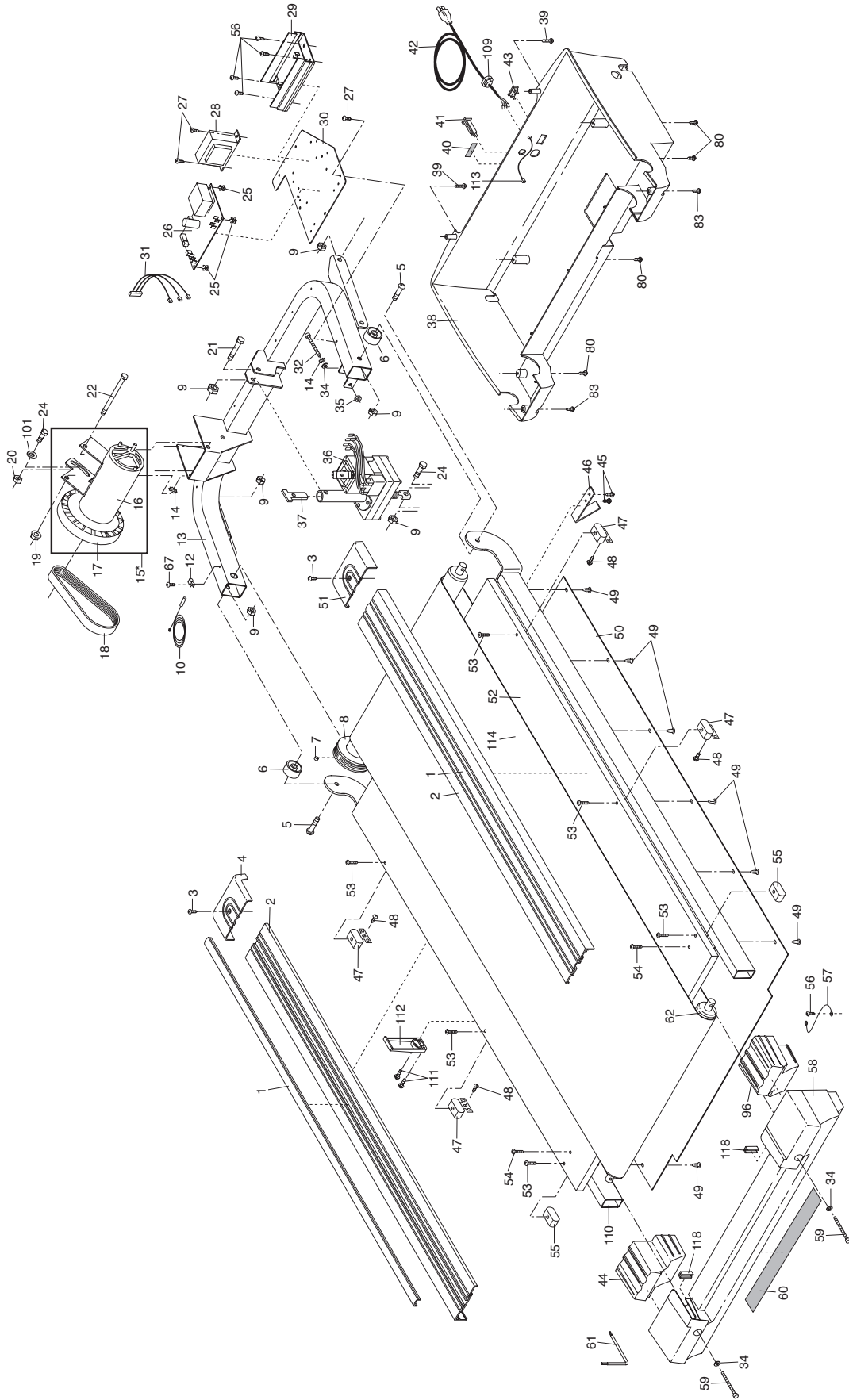

# EXPLODED DRAWING—Model No. PFTL79192

R0100A

