

EXPLODED DRAWING A

Model No. PFTL79511.0 R1012B

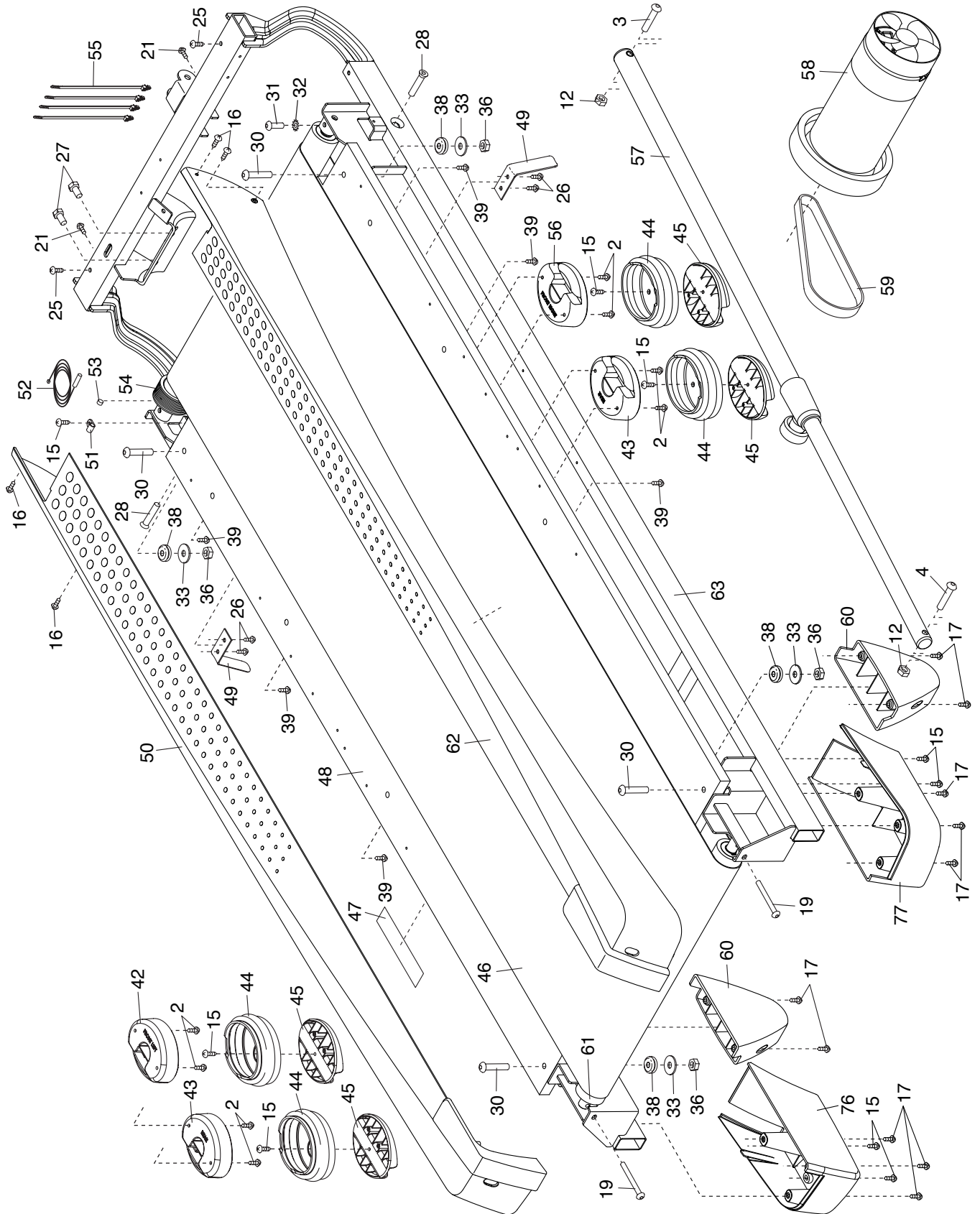

EXPLODED DRAWING B

Model No. PFTL79511.0 R1012B

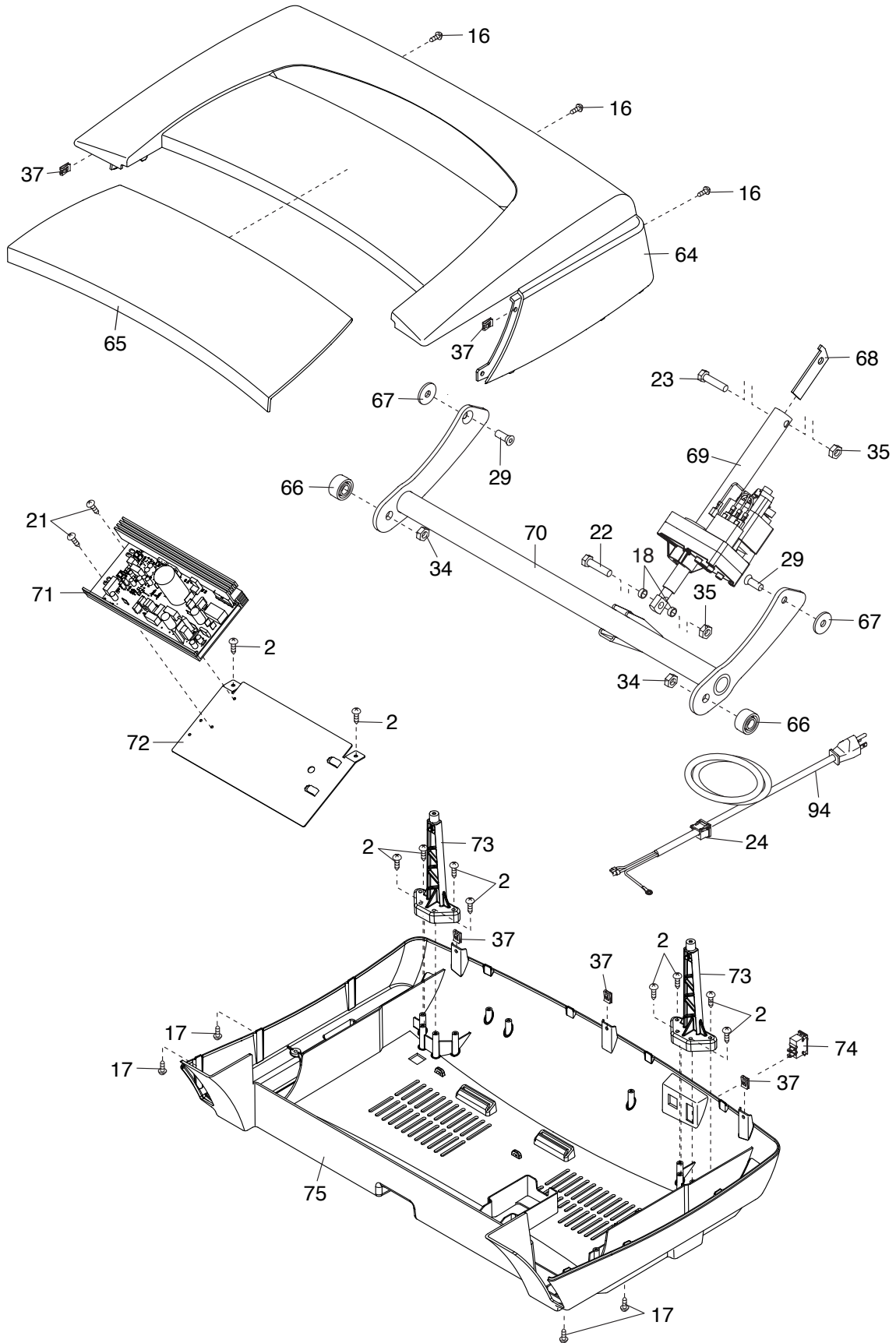

EXPLODED DRAWING C

Model No. PFTL79511.0 R1012B

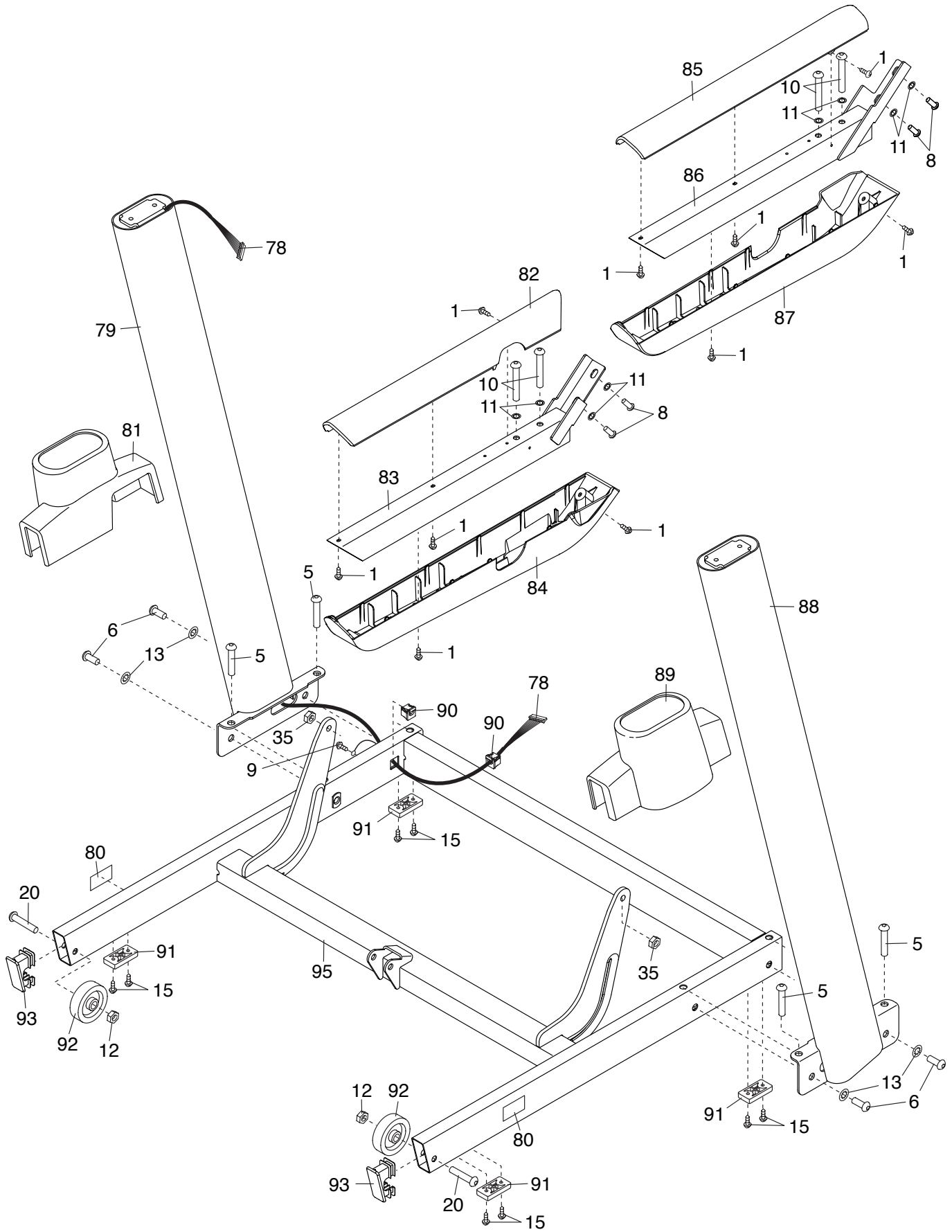

EXPLODED DRAWING D

Model No. PFTL79511.0 R1012B

