

EXPLODED DRAWING A

Model No. PFTL79511.2 R0515A

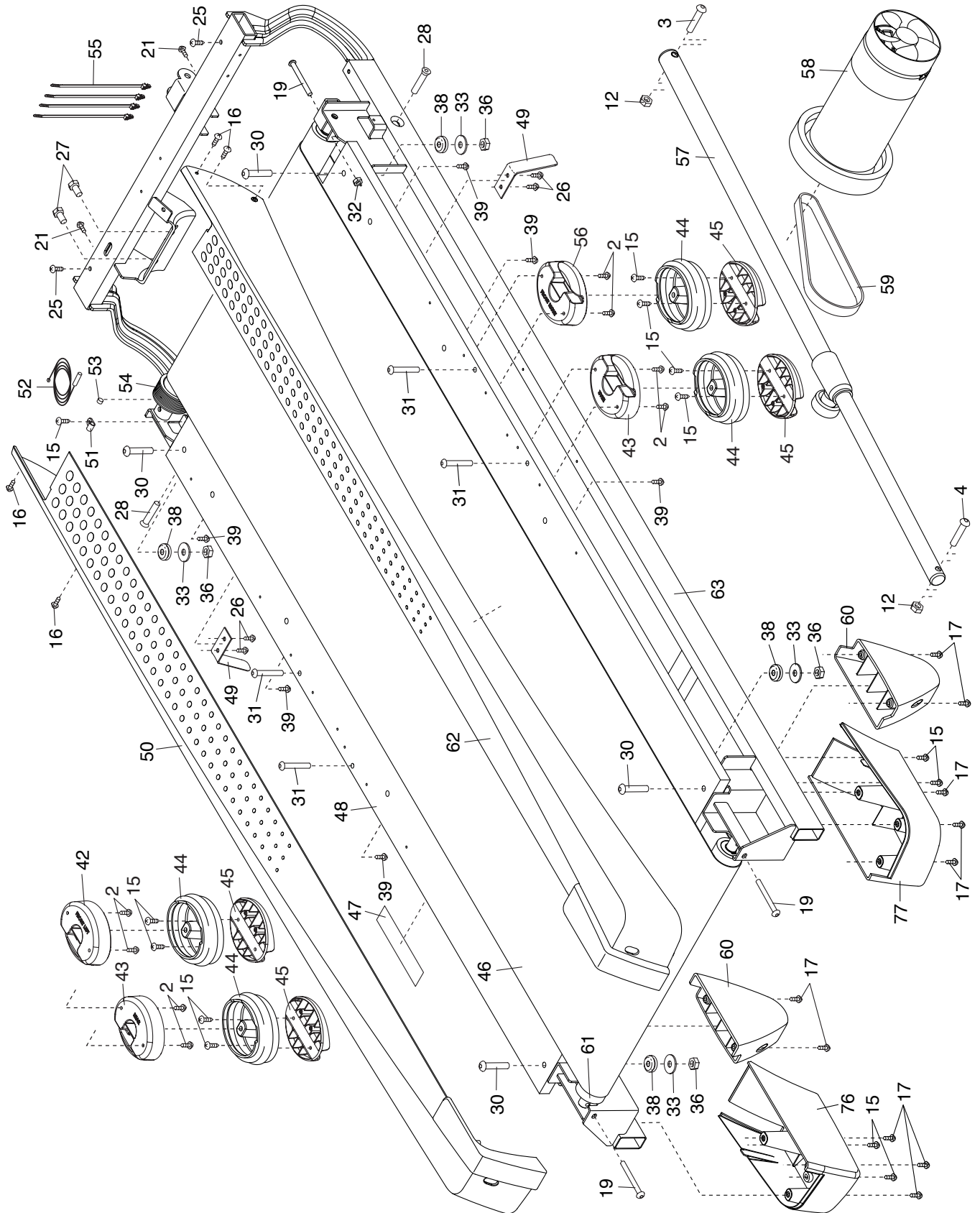

EXPLODED DRAWING C

Model No. PFTL79511.2 R0515A

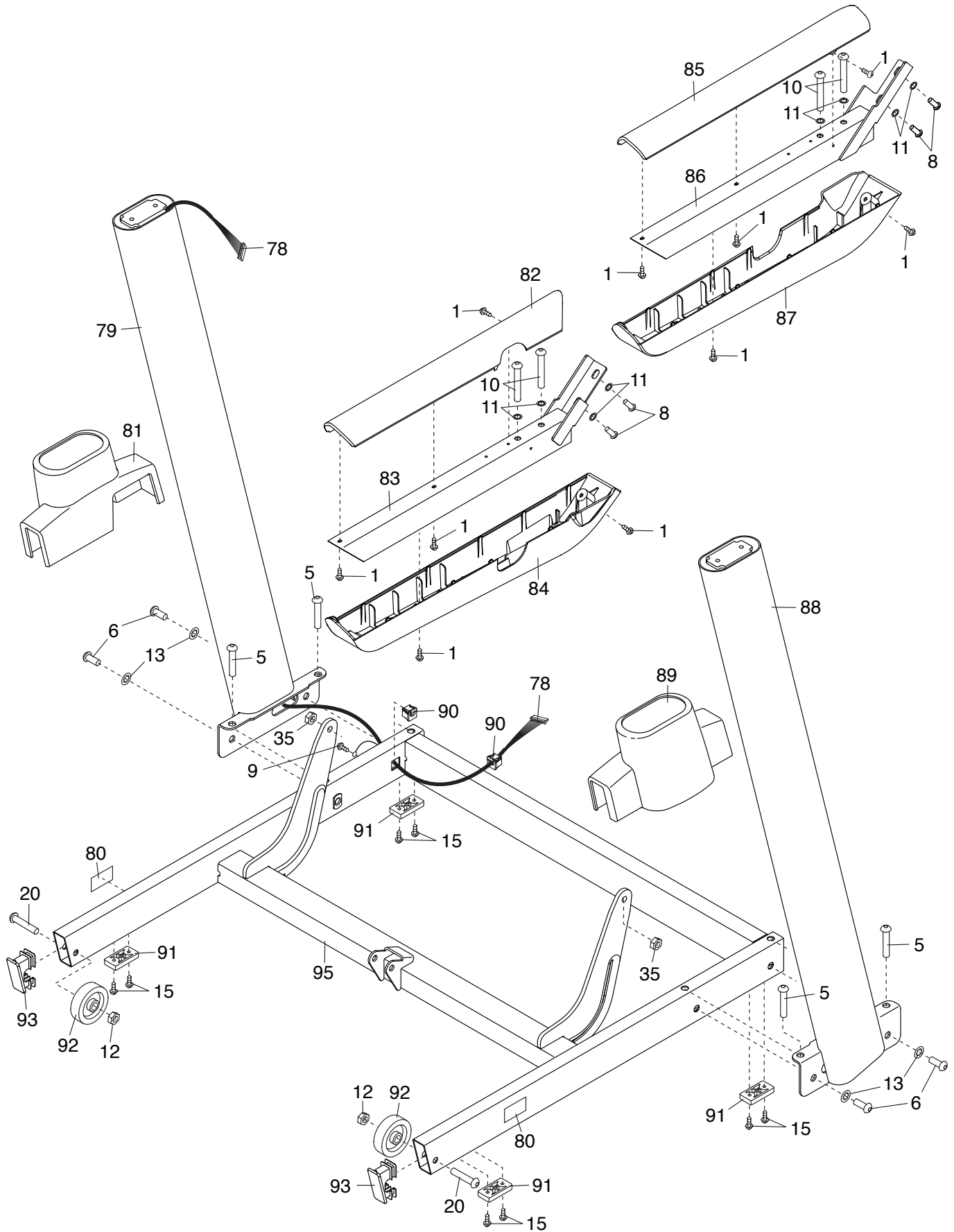

EXPLODED DRAWING D

Model No. PFTL79511.2 R0515A

