

EXPLODED DRAWING A

Model No. PFTL79513.0 R0913A

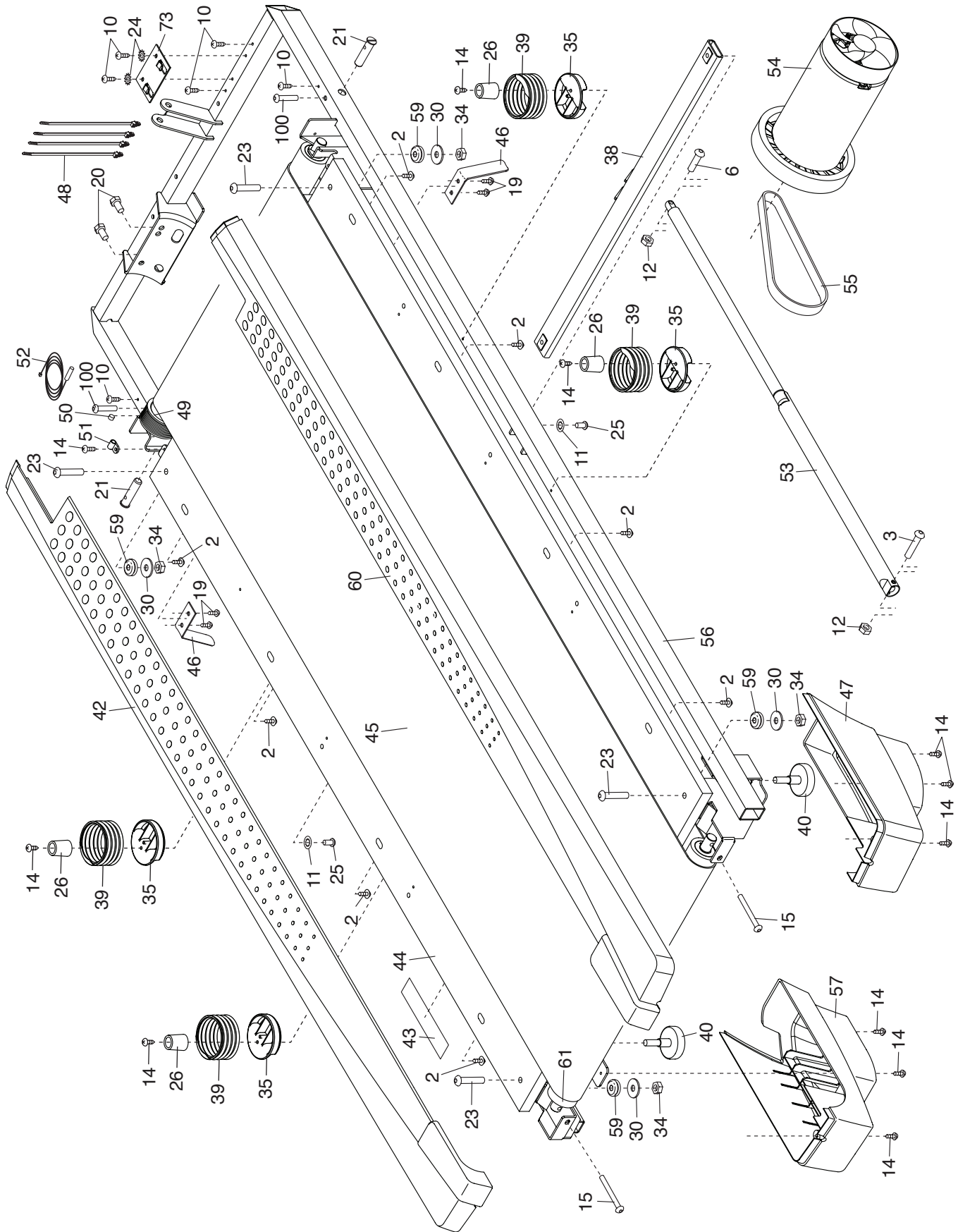

EXPLODED DRAWING B

Model No. PFTL79513.0 R0913A

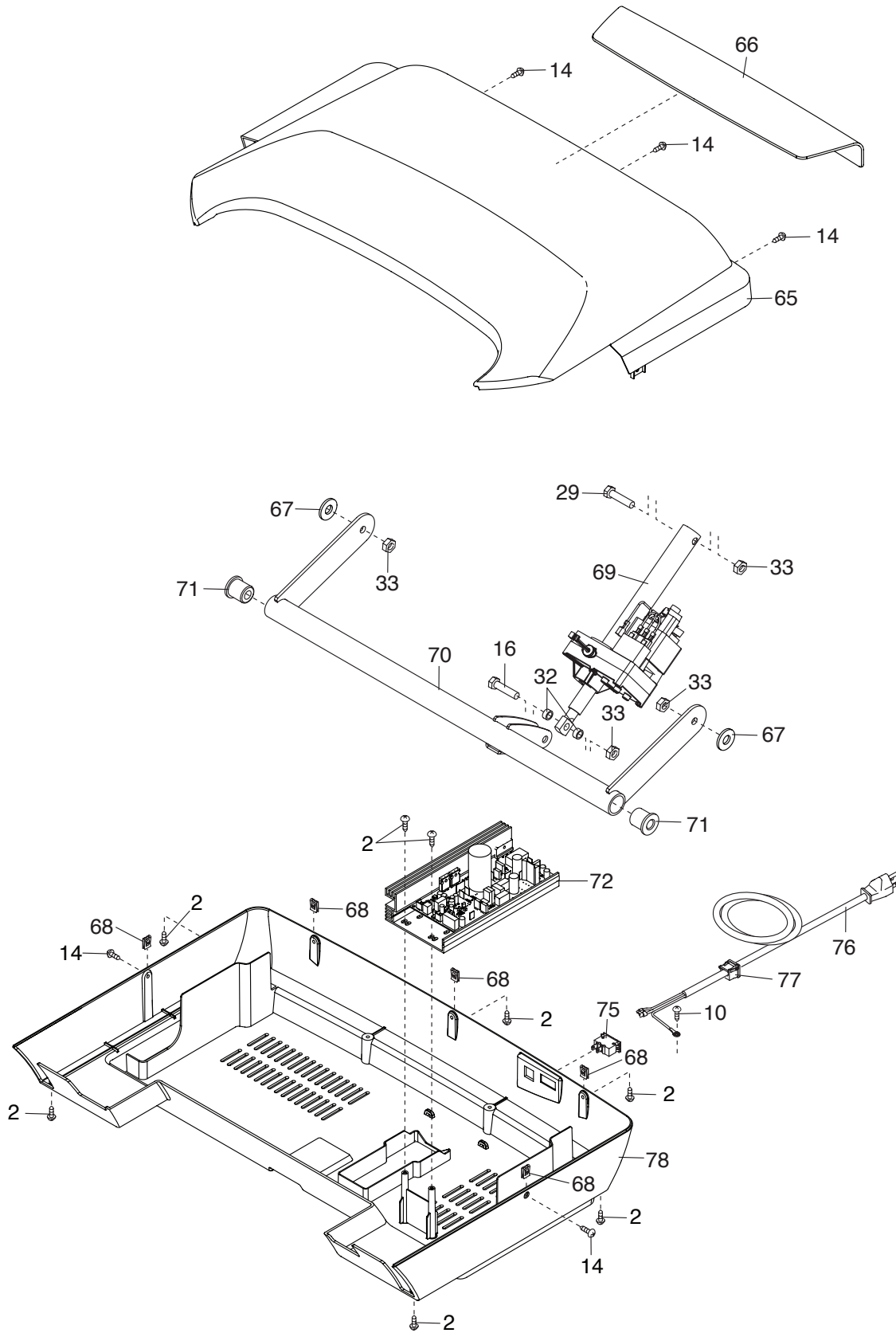

EXPLODED DRAWING C

Model No. PFTL79513.0 R0913A

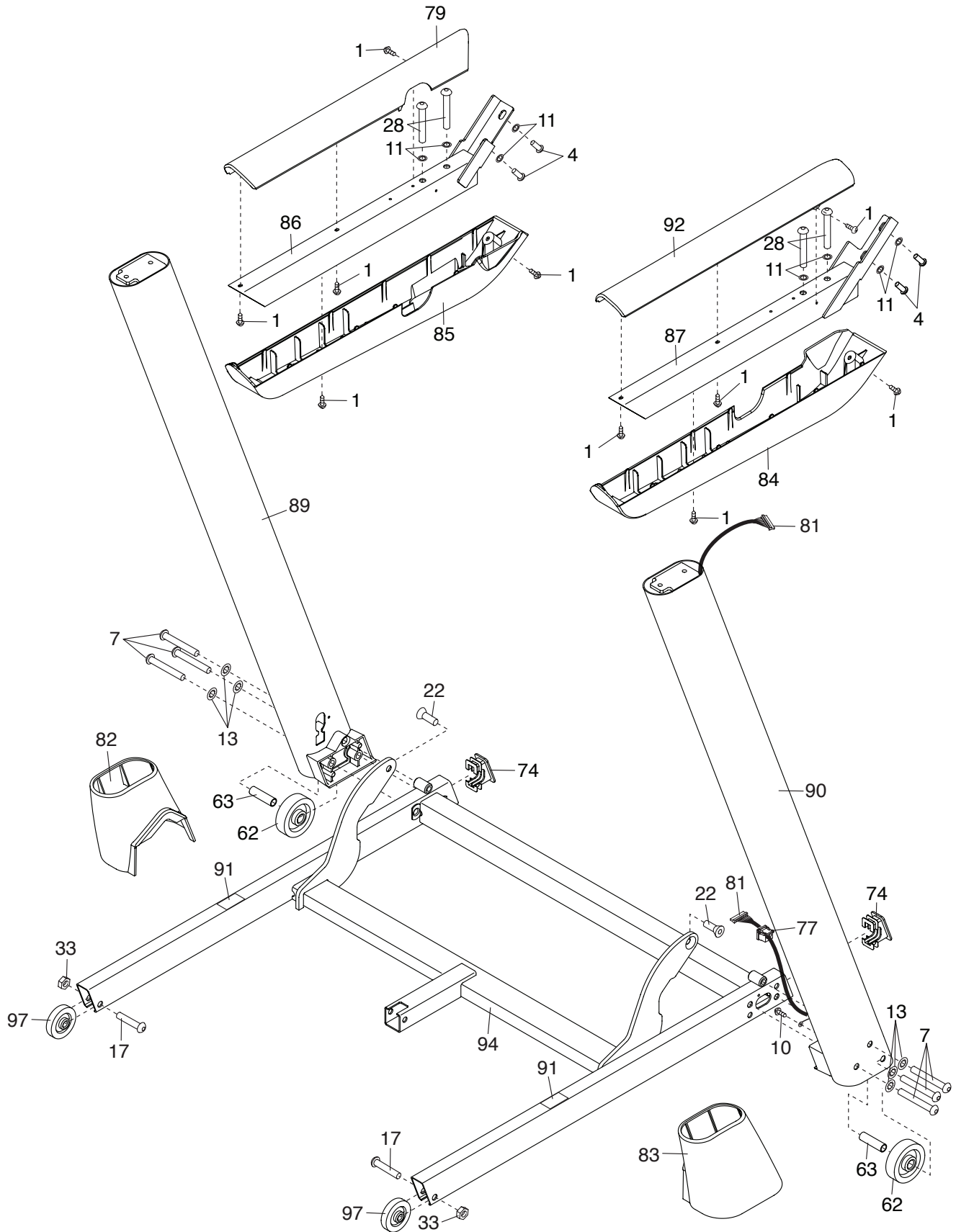

EXPLODED DRAWING D

Model No. PFTL79513.0 R0913A

