

EXPLODED DRAWING A

Model No. PFTL79513.4 R1014A

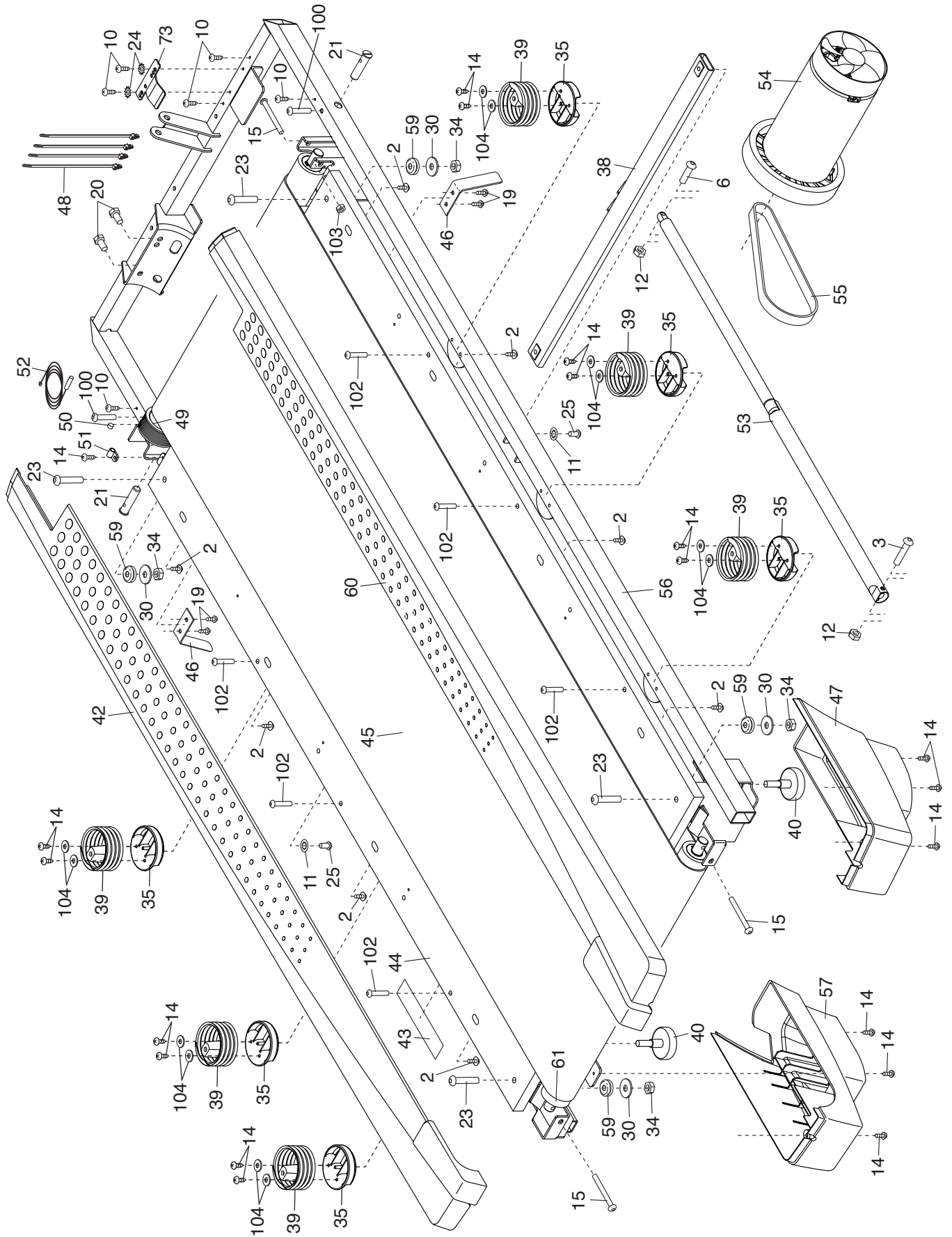

EXPLODED DRAWING B

Model No. PFTL79513.4 R1014A

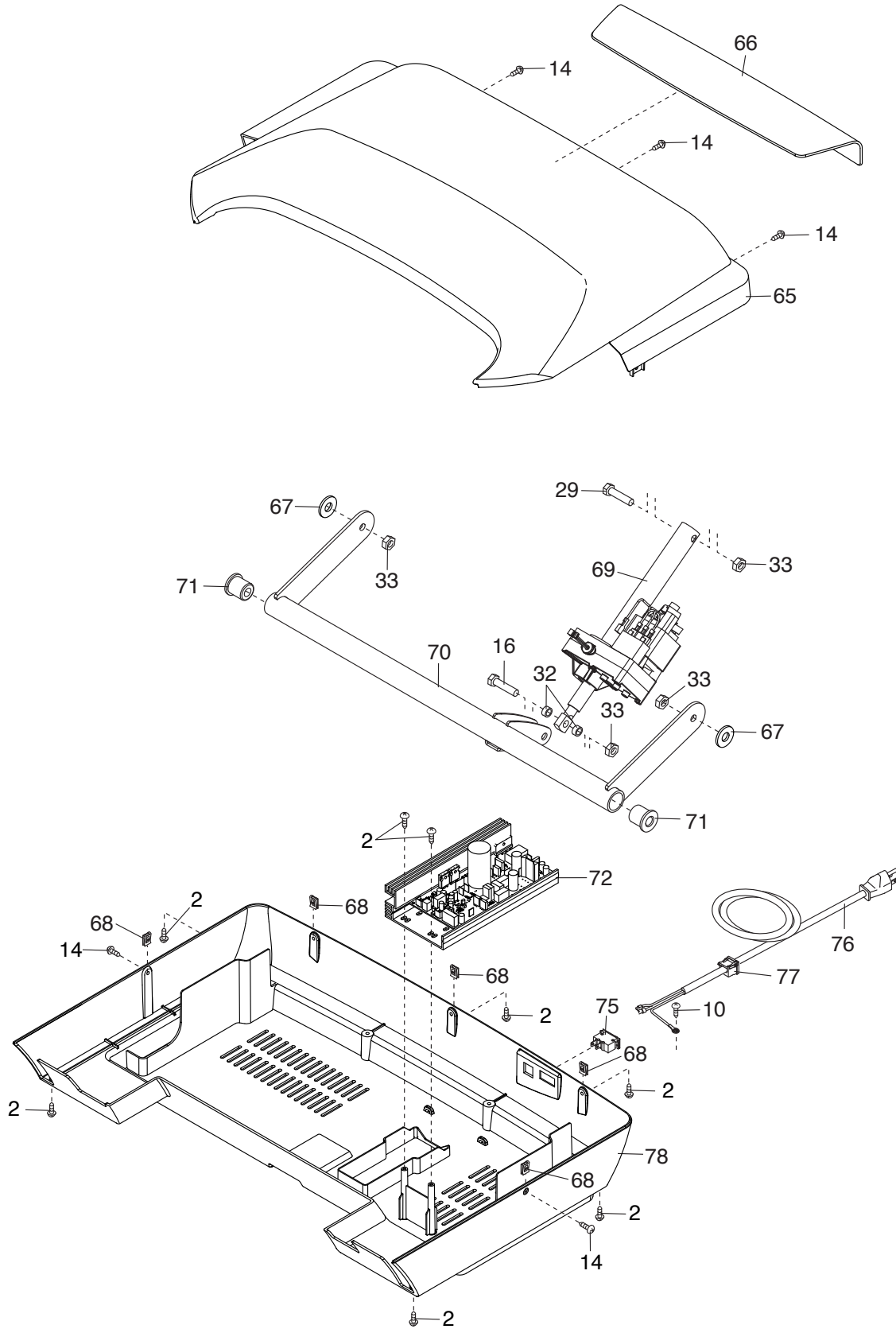

EXPLODED DRAWING D

Model No. PFTL79513.4 R1014A

