

EXPLODED DRAWING A

Model No. PFTL79513.3 R0914A

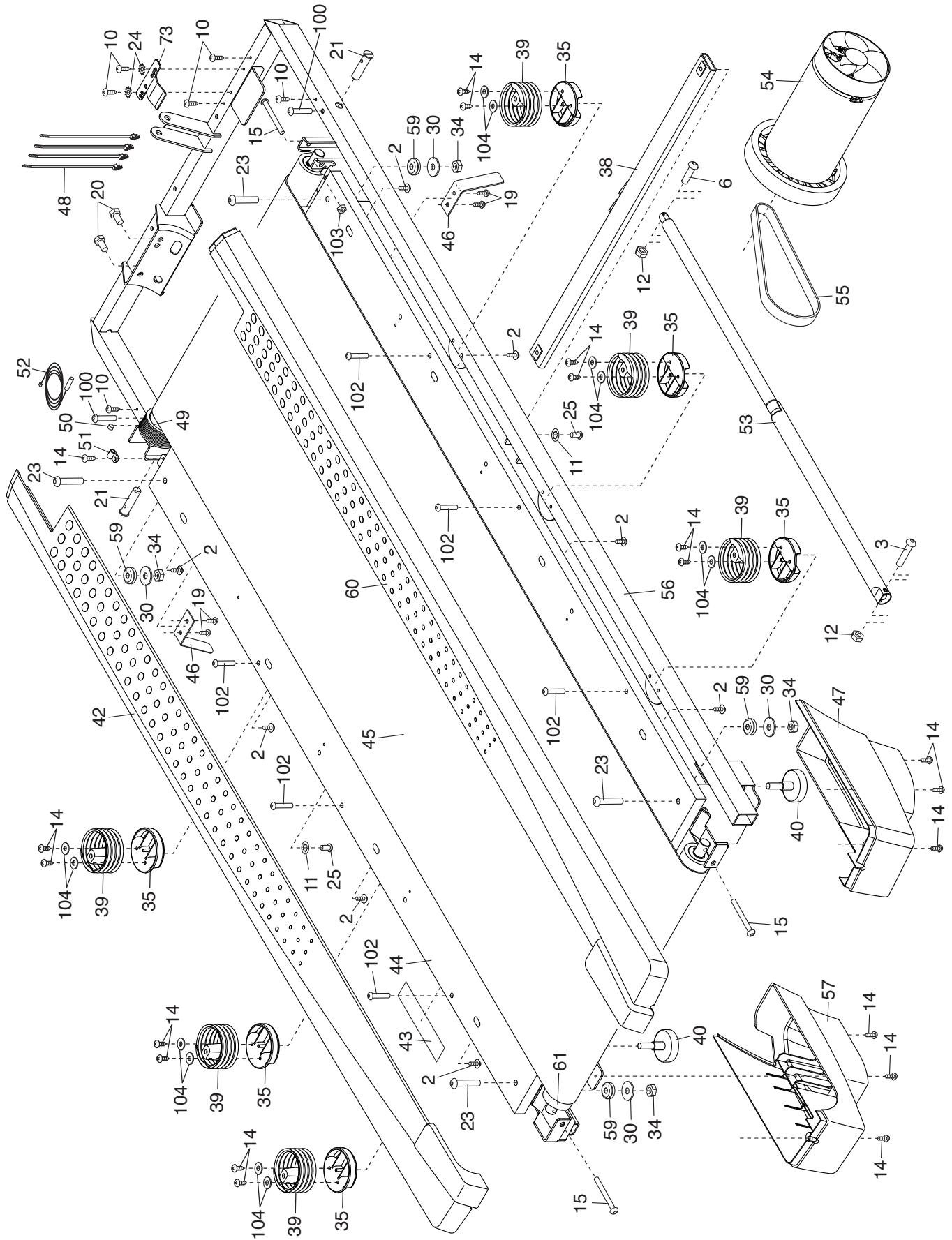

EXPLODED DRAWING B

Model No. PFTL79513.3 R0914A

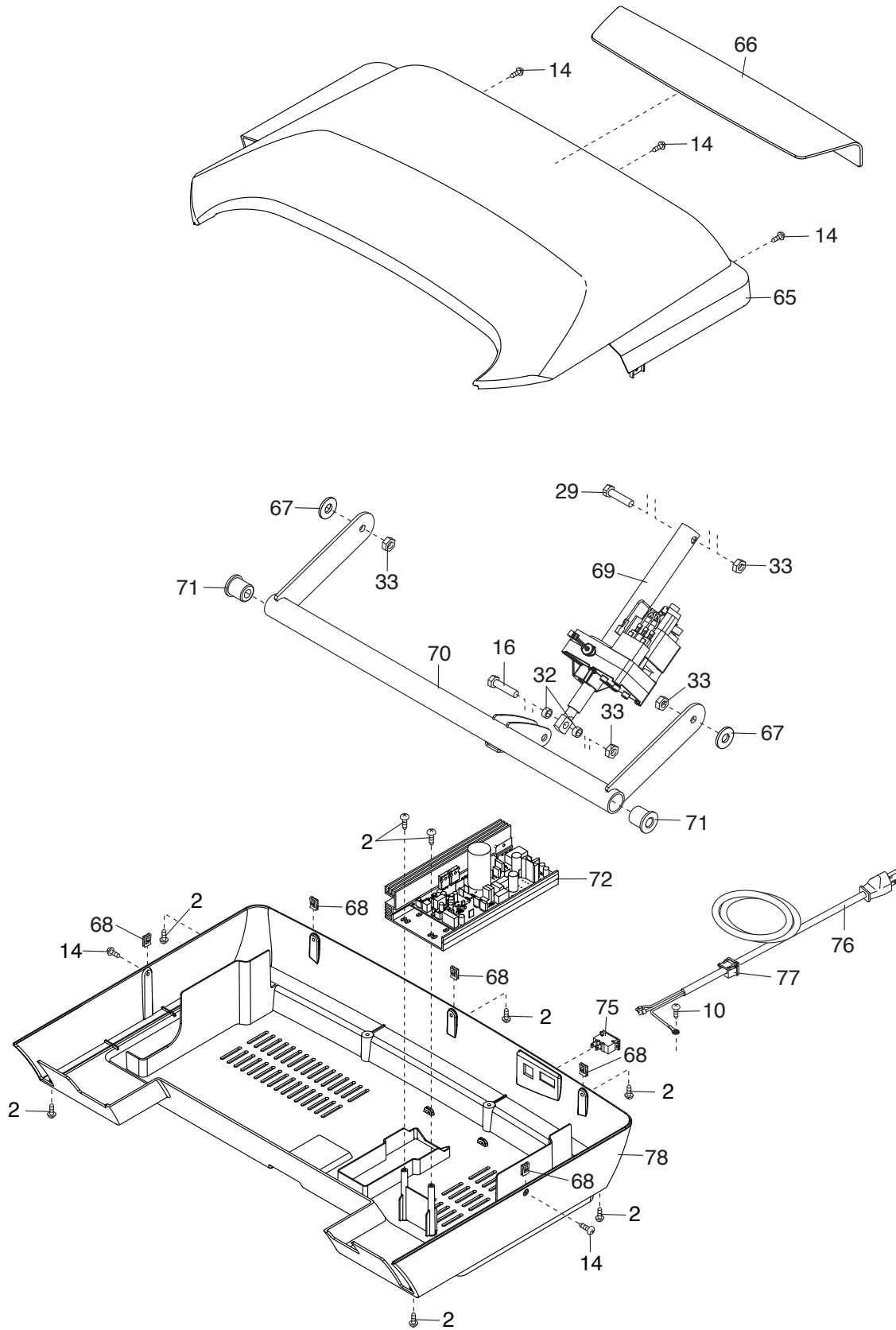

EXPLODED DRAWING C

Model No. PFTL79513.3 R0914A

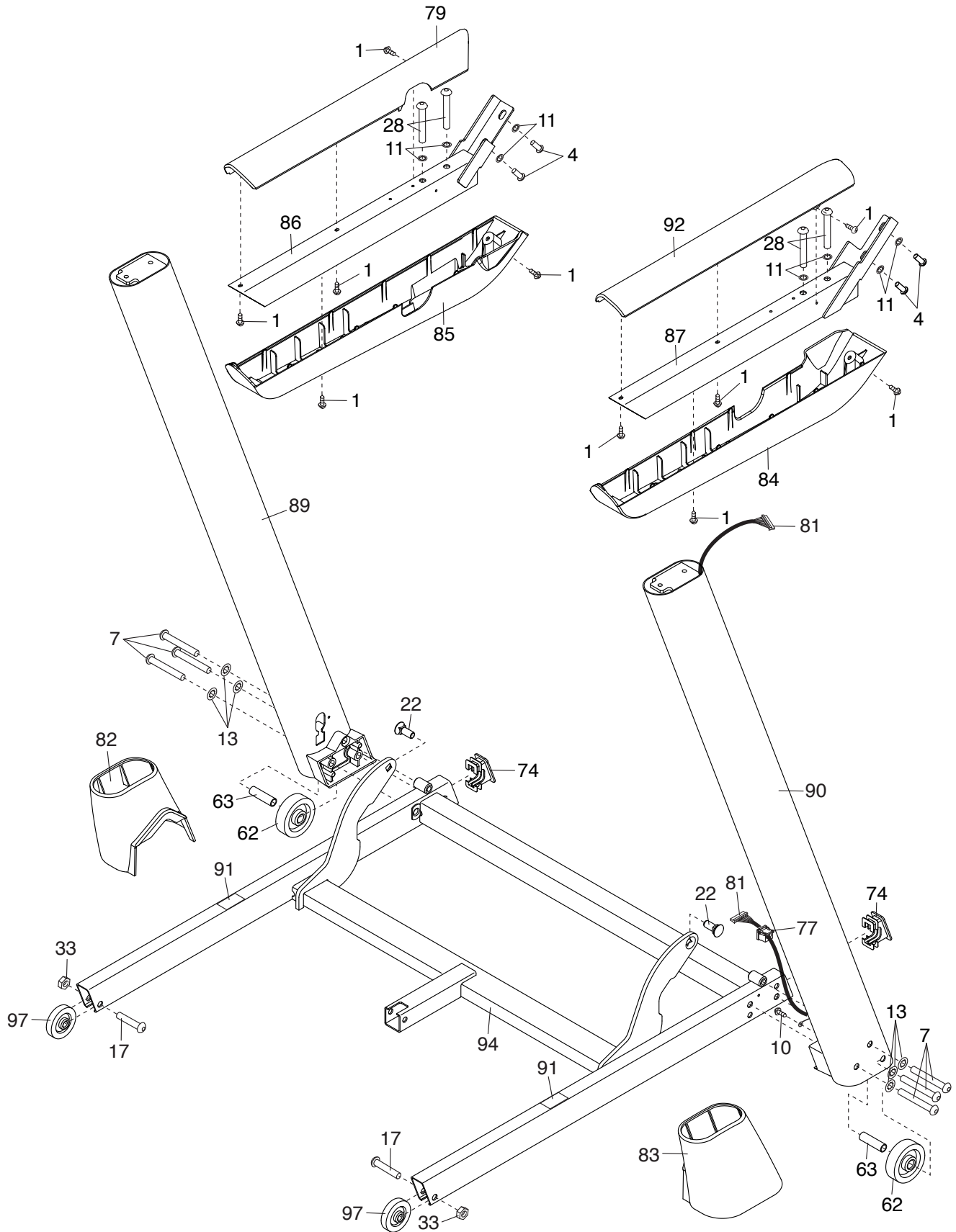

EXPLODED DRAWING D

Model No. PFTL79513.3 R0914A

