

EXPLODED DRAWING A

Model No. PFTL79515.0 R1115A

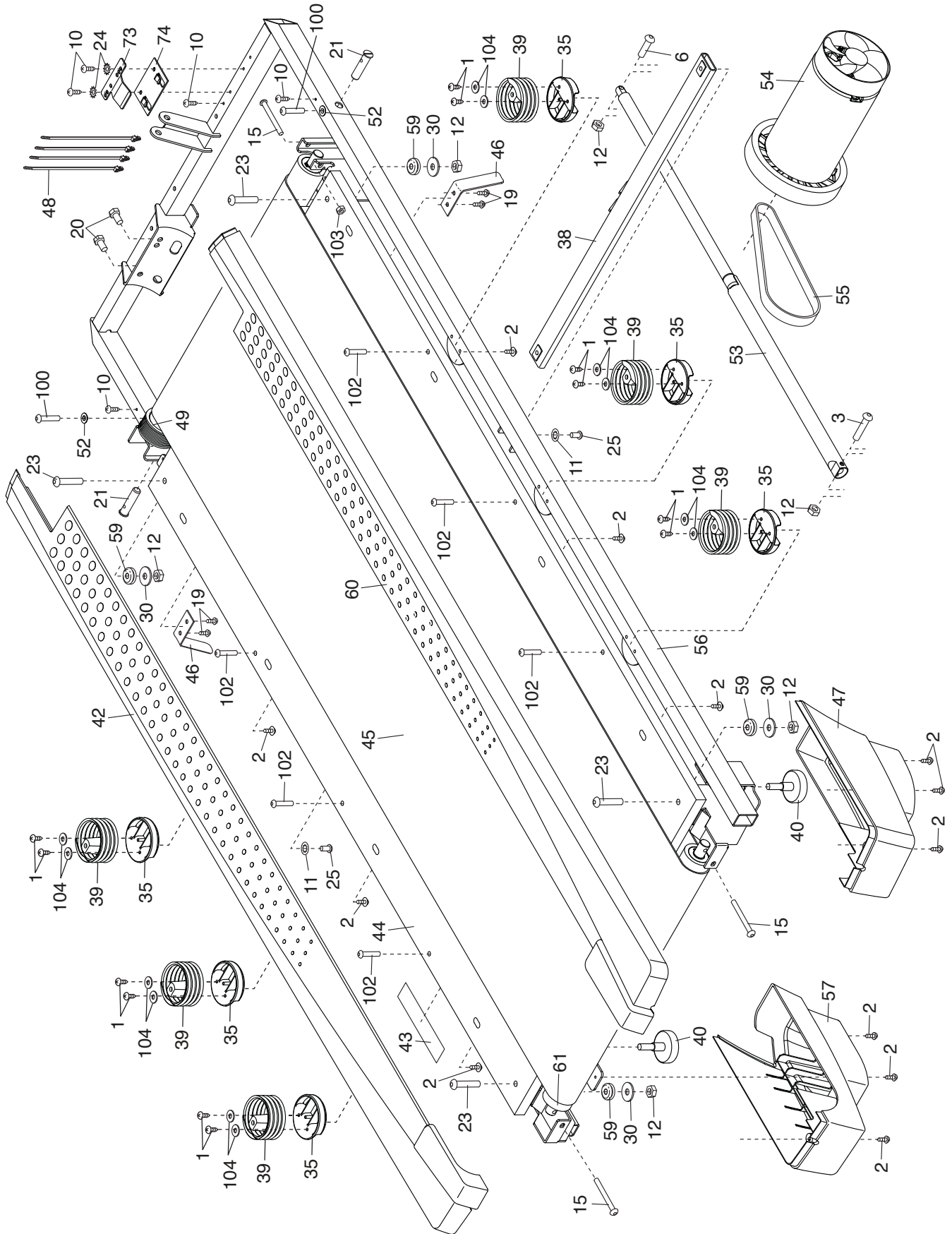

EXPLODED DRAWING B

Model No. PFTL79515.0 R1115A

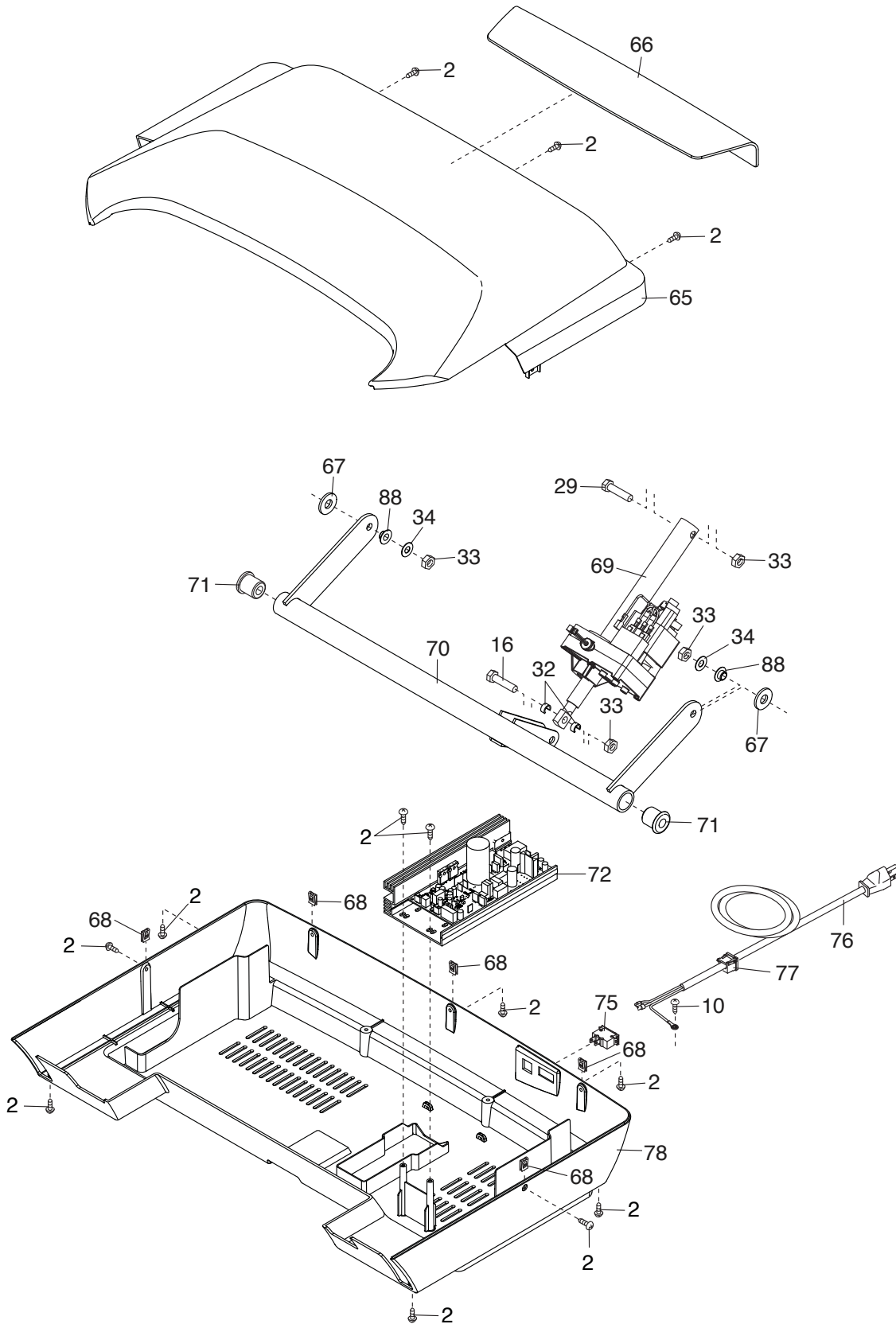

EXPLODED DRAWING C

Model No. PFTL79515.0 R1115A

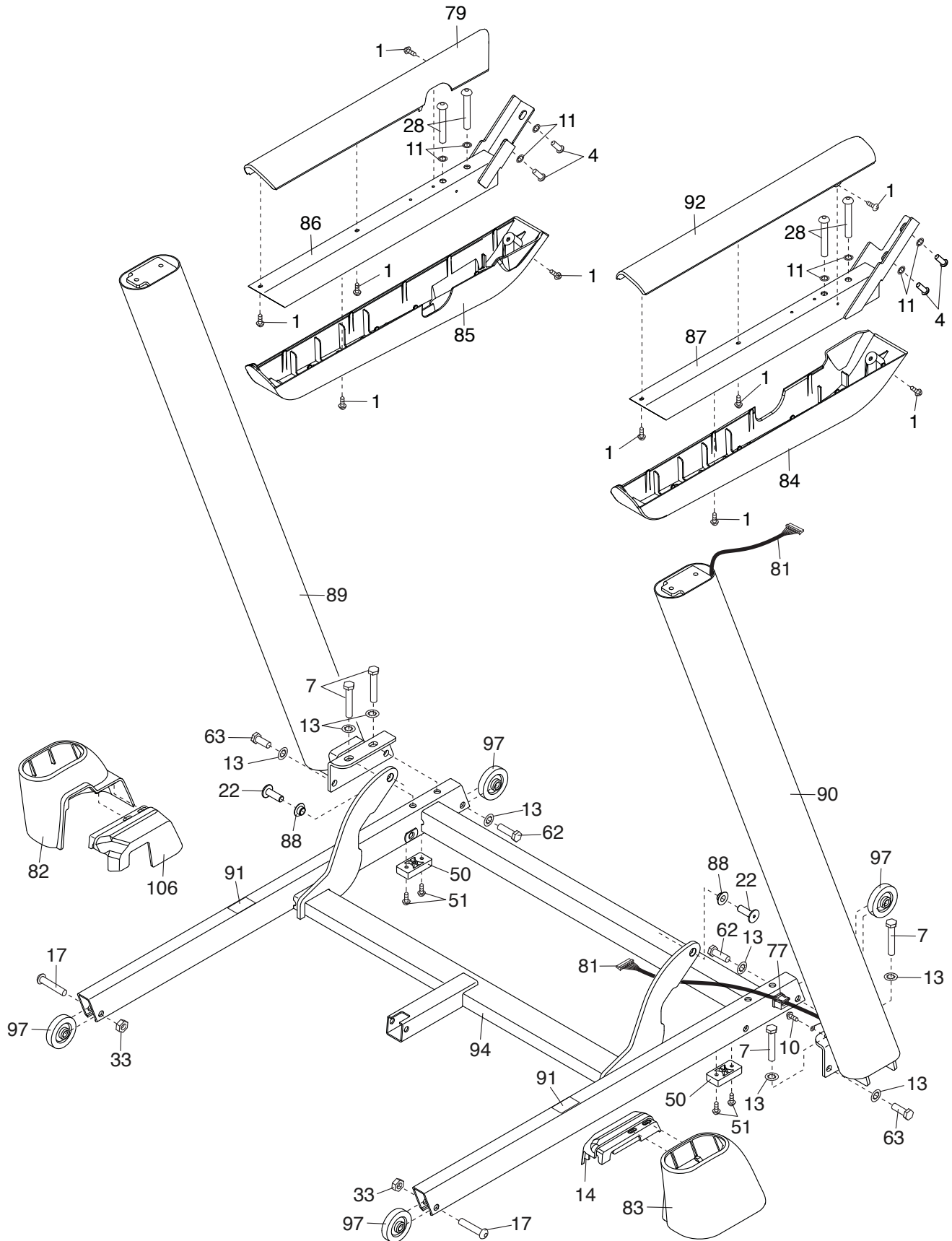

EXPLODED DRAWING D

Model No. PFTL79515.0 R1115A

