

EXPLODED DRAWING B

Model No. PFTL79515.1 R0416A

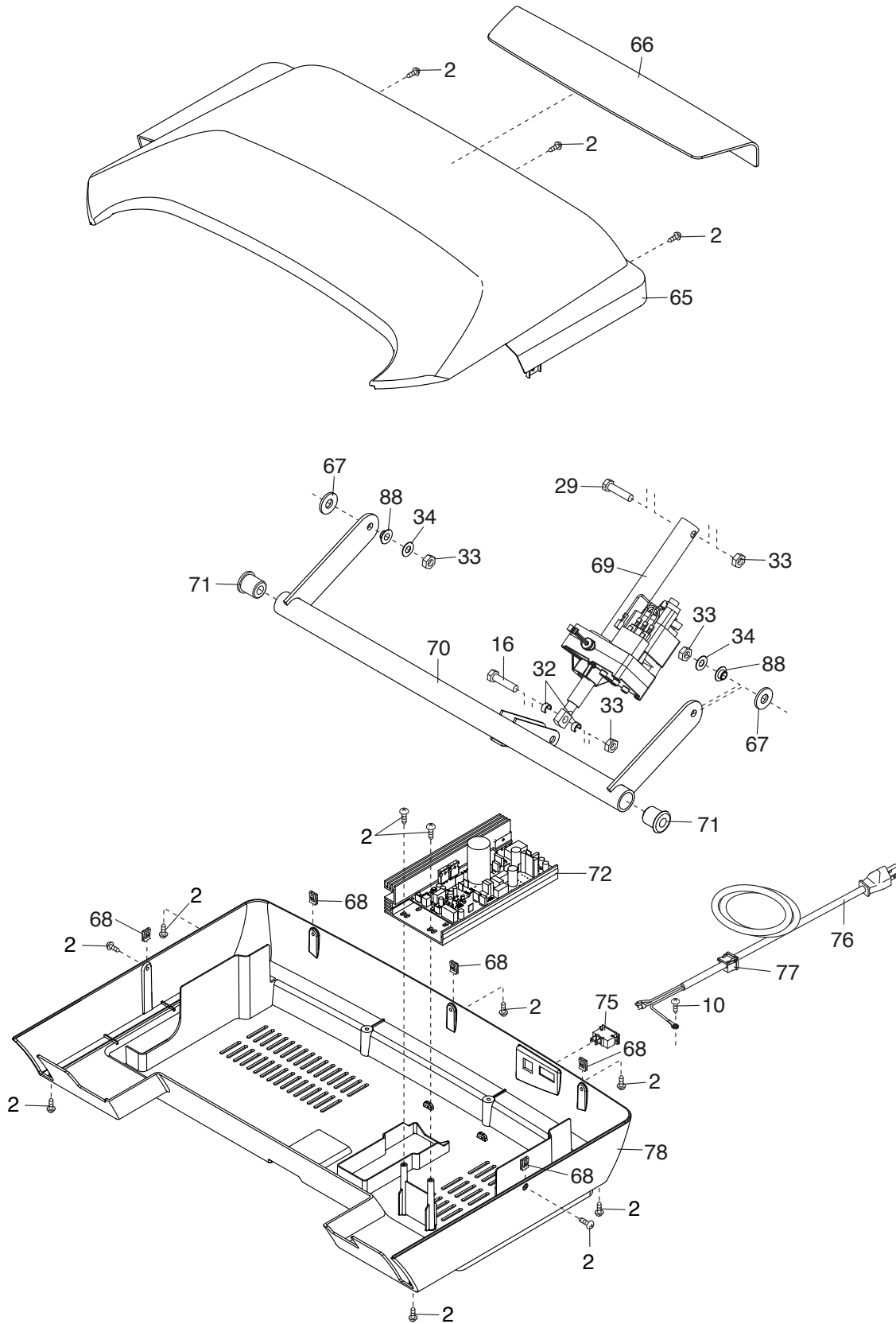

EXPLODED DRAWING C

Model No. PFTL79515.1 R0416A

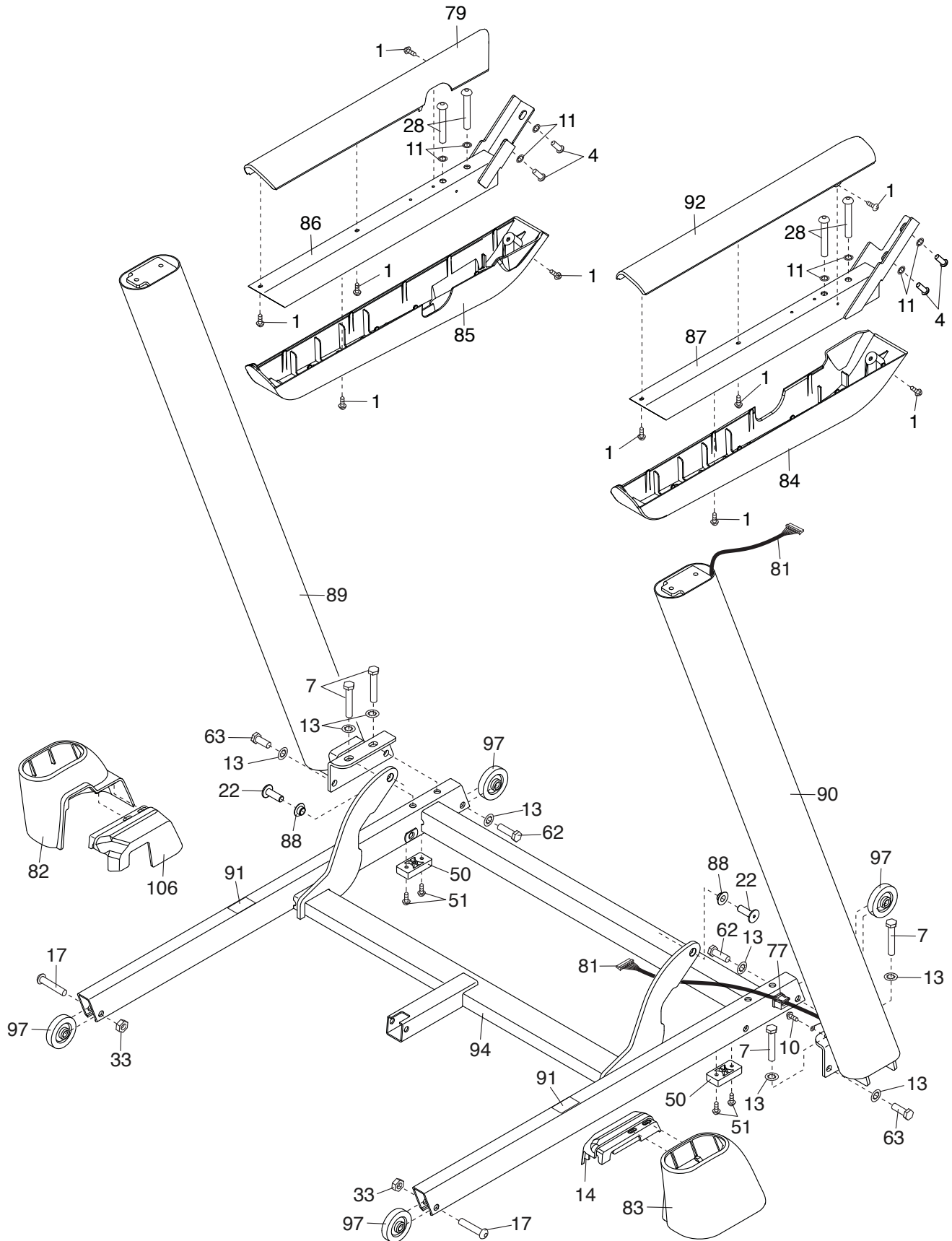

EXPLODED DRAWING D

Model No. PFTL79515.1 R0416A

