

EXPLODED DRAWING B

Model No. PFTL79515.5 R1217A

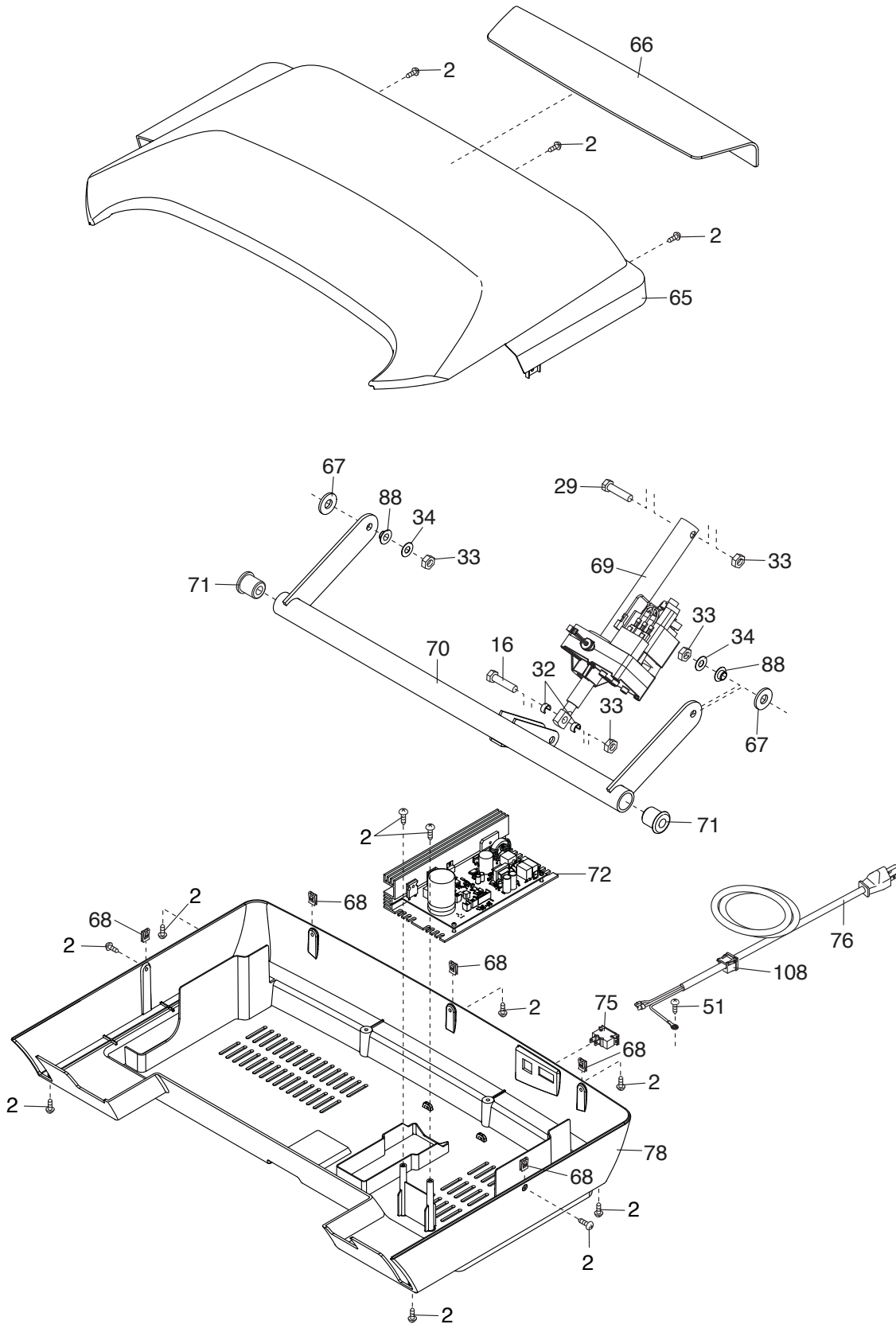

EXPLODED DRAWING C

Model No. PFTL79515.5 R1217A

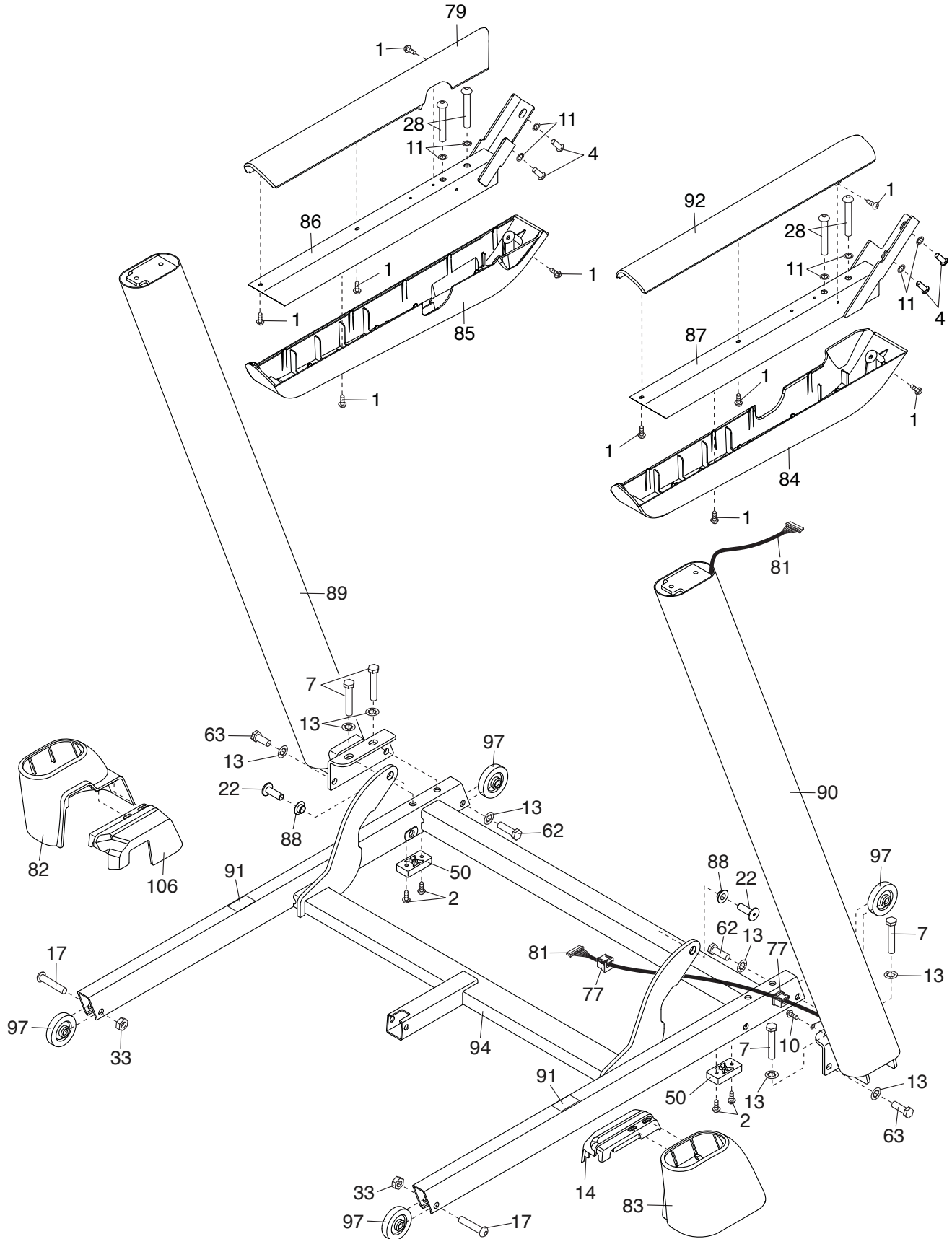

EXPLODED DRAWING D

Model No. PFTL79515.5 R1217A

