

EXPLODED DRAWING A

Model No. PFTL79518.0 R1018A

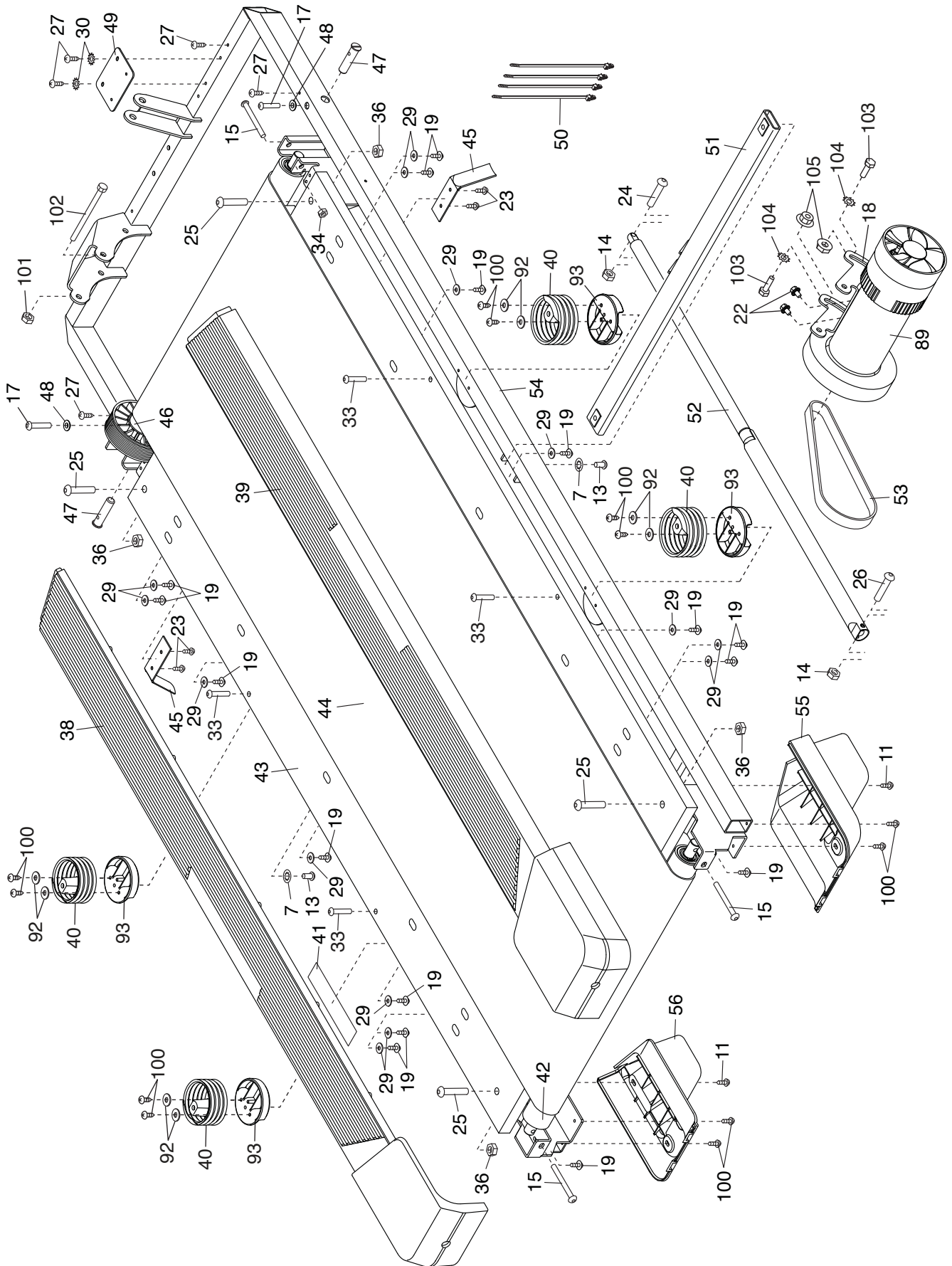

EXPLODED DRAWING B

Model No. PFTL79518.0 R1018A

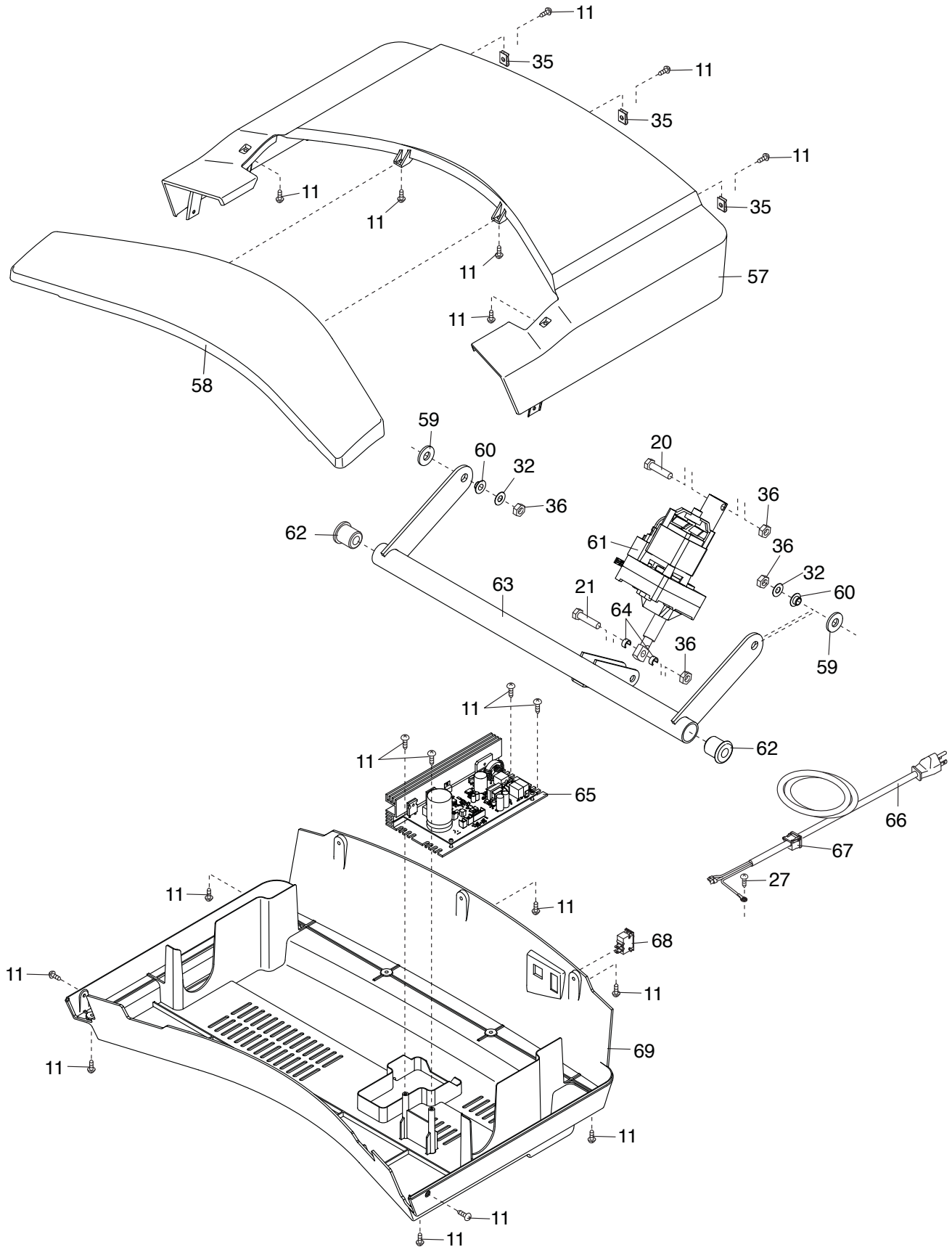

EXPLODED DRAWING C

Model No. PFTL79518.0 R1018A

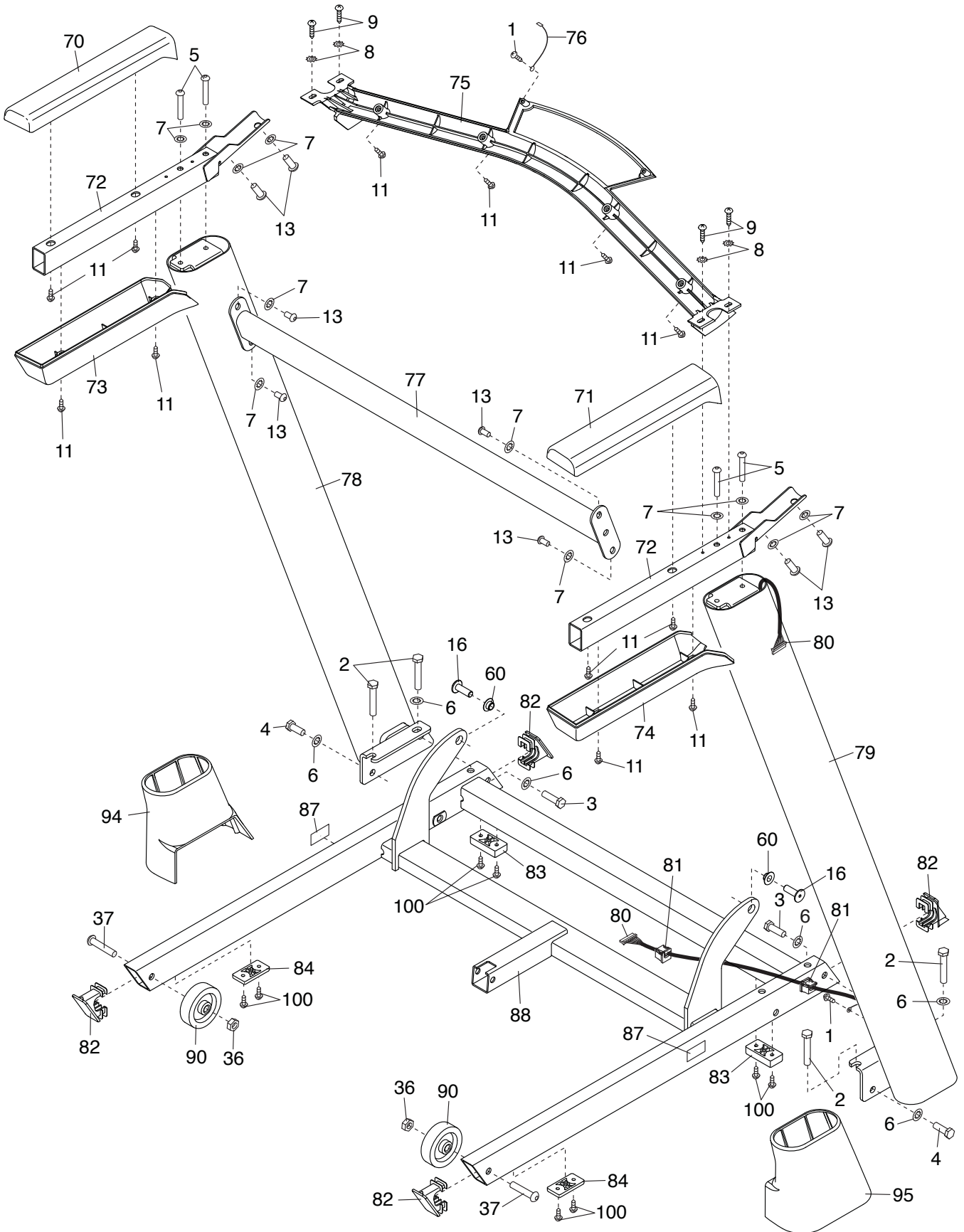

EXPLODED DRAWING D

Model No. PFTL79518.0 R1018A

