

EXPLODED DRAWING A

Model No. PFTL79611.0 R0113A

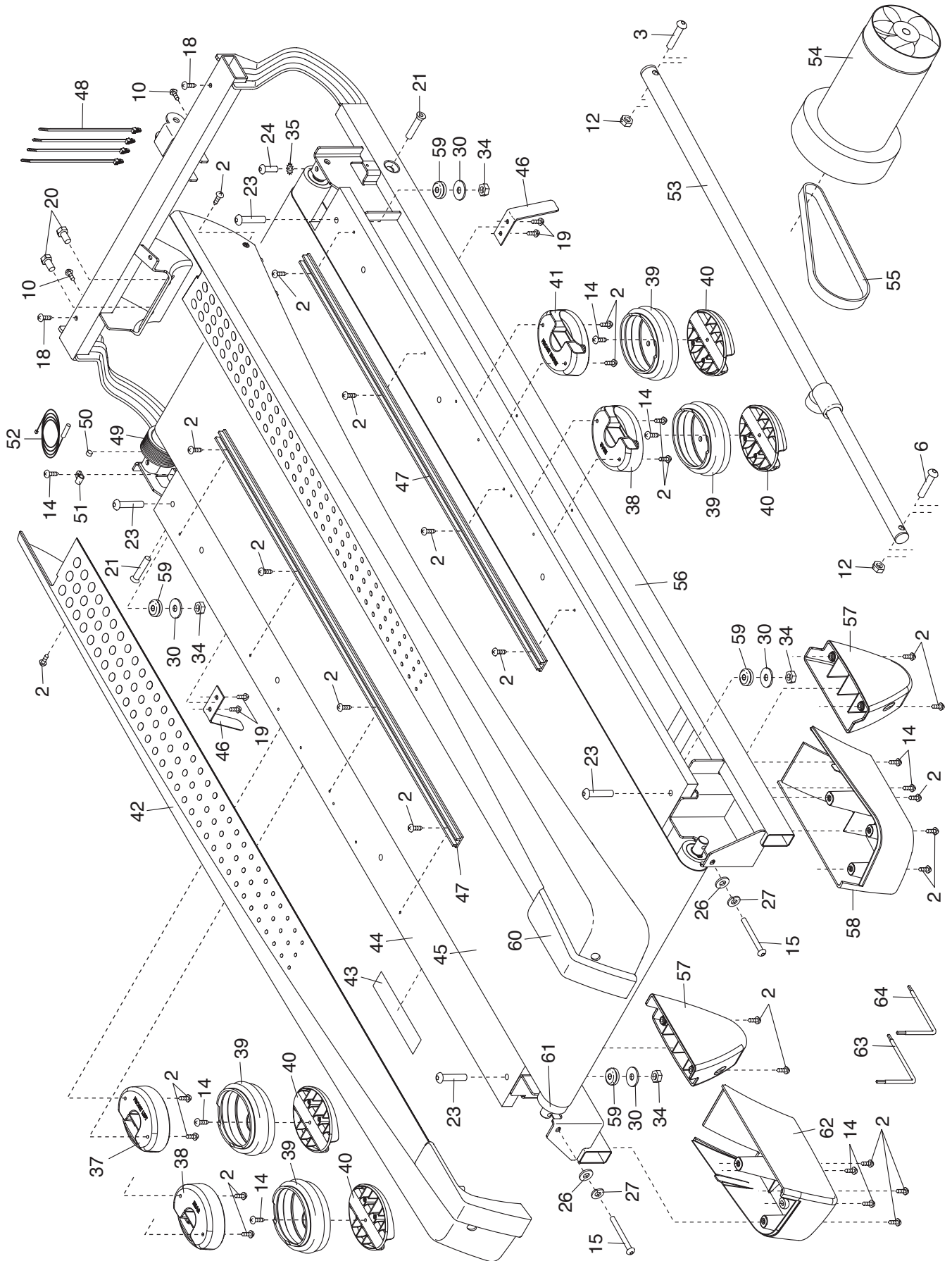

EXPLODED DRAWING B

Model No. PFTL79611.0 R0113A

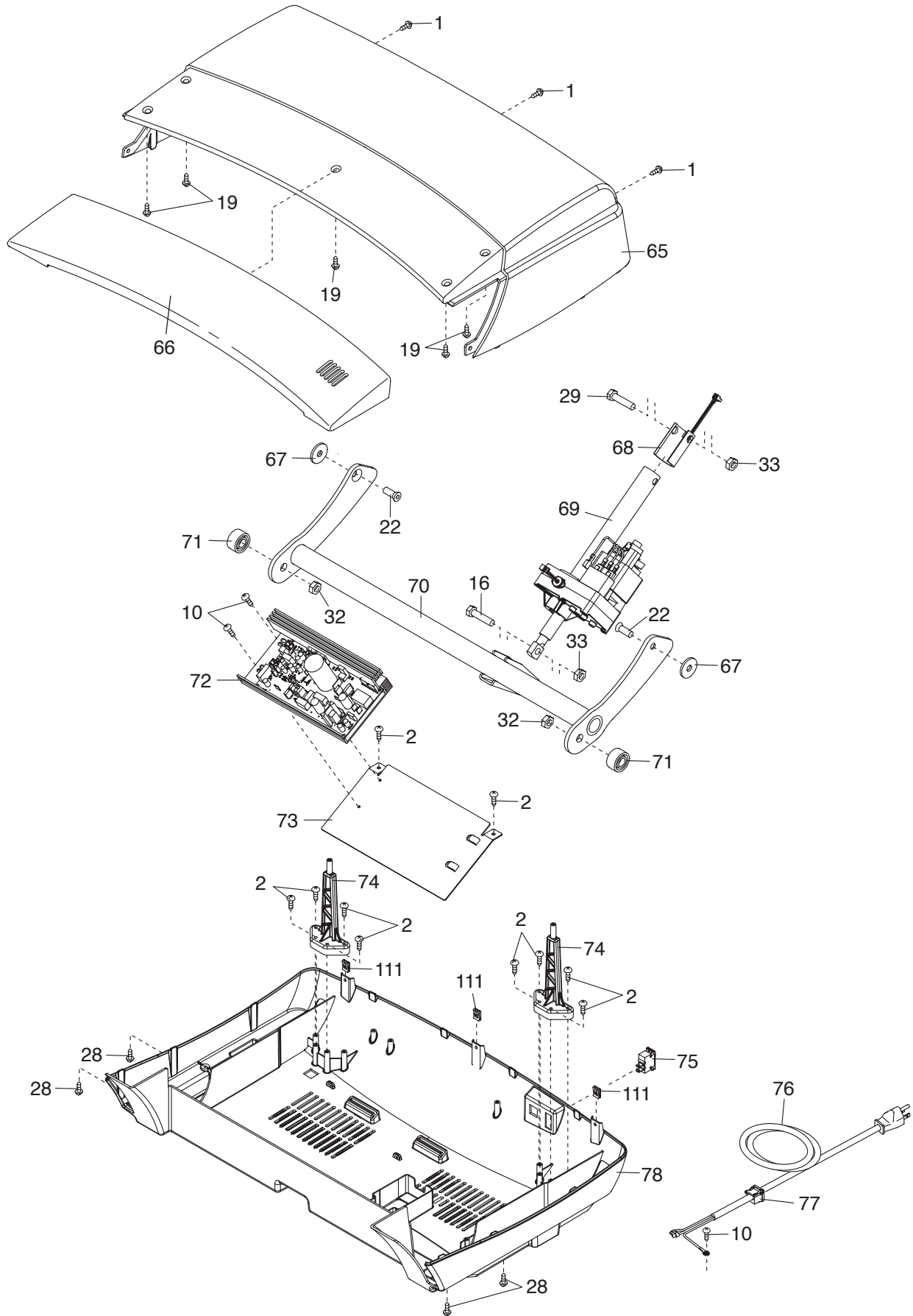

EXPLODED DRAWING C

Model No. PFTL79611.0 R0113A

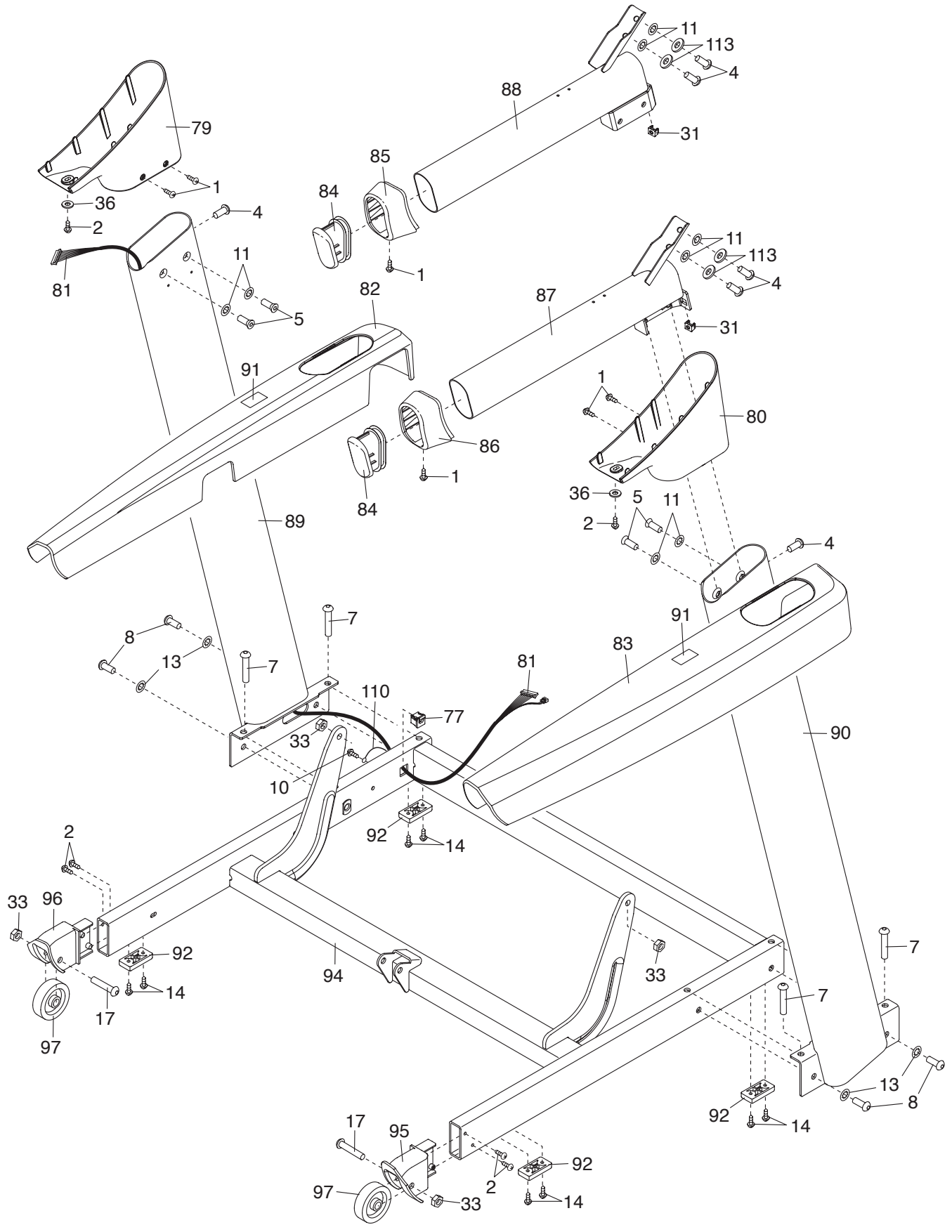

EXPLODED DRAWING D

Model No. PFTL79611.0 R0113A

