

EXPLODED DRAWING A

Model No. PFTL79614.0 R0614A

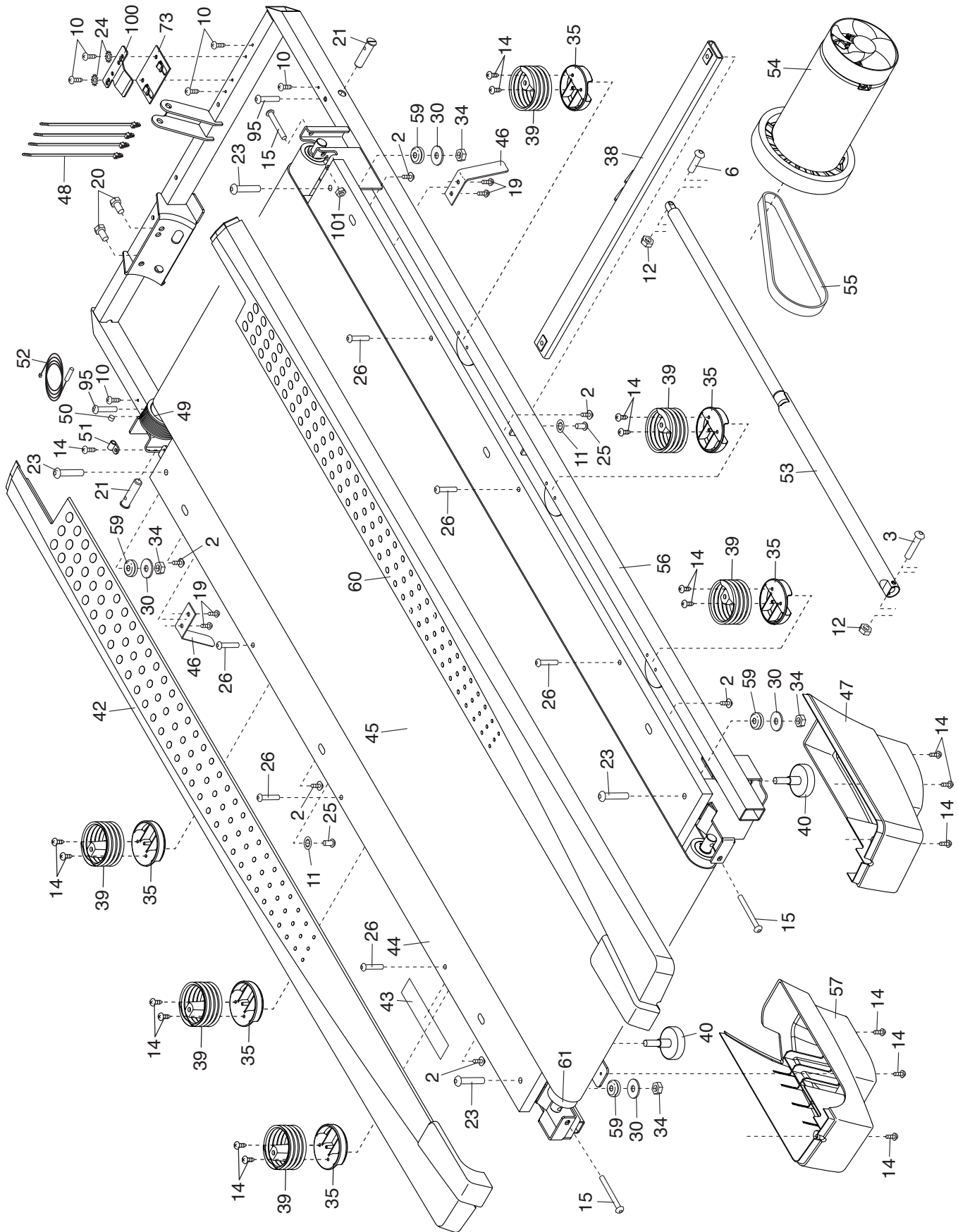

EXPLODED DRAWING B

Model No. PFTL79614.0 R0614A

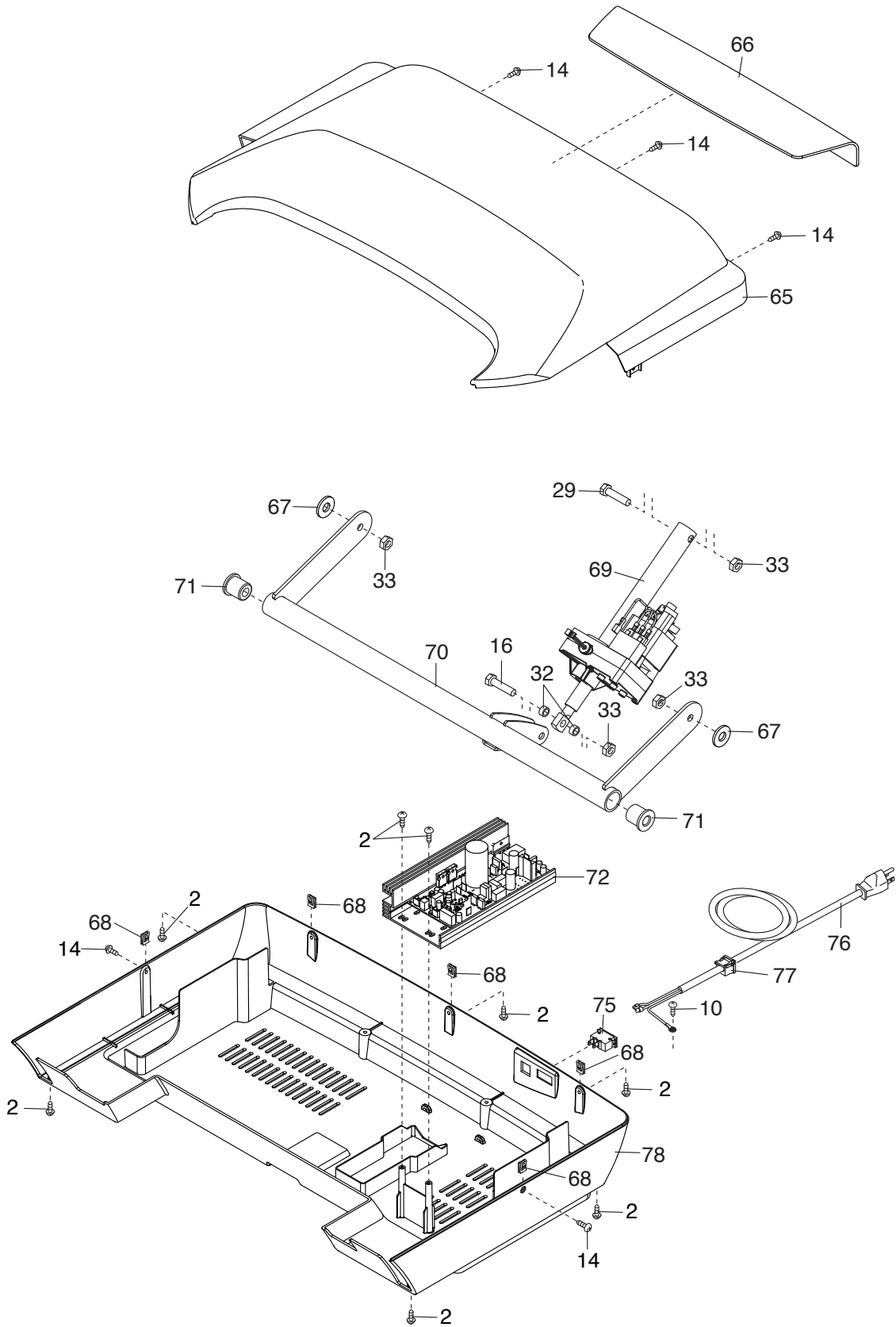

EXPLODED DRAWING C

Model No. PFTL79614.0 R0614A

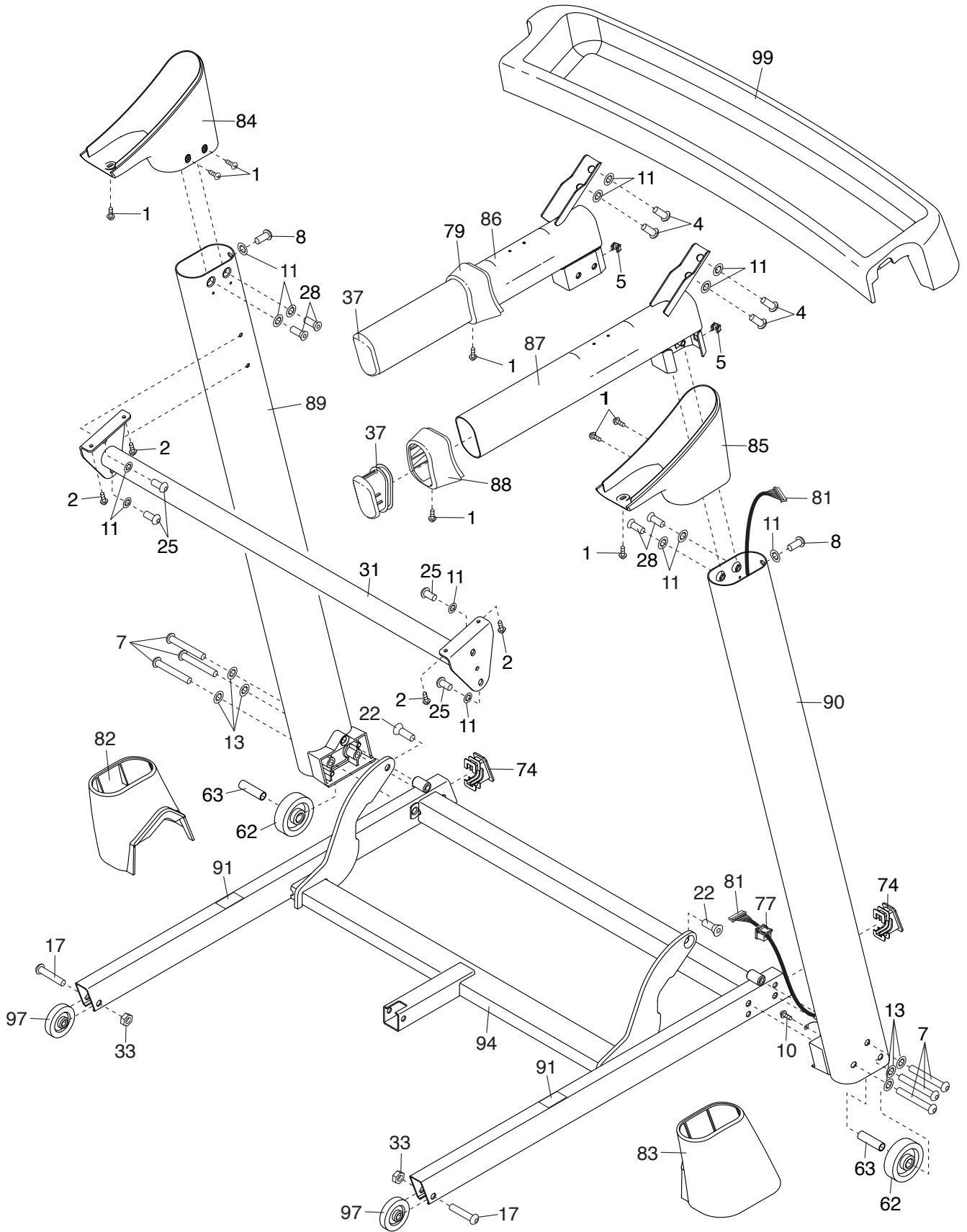

EXPLODED DRAWING D

Model No. PFTL79614.0 R0614A

