

EXPLODED DRAWING A—Model No. PFTL79807.0

R1007A

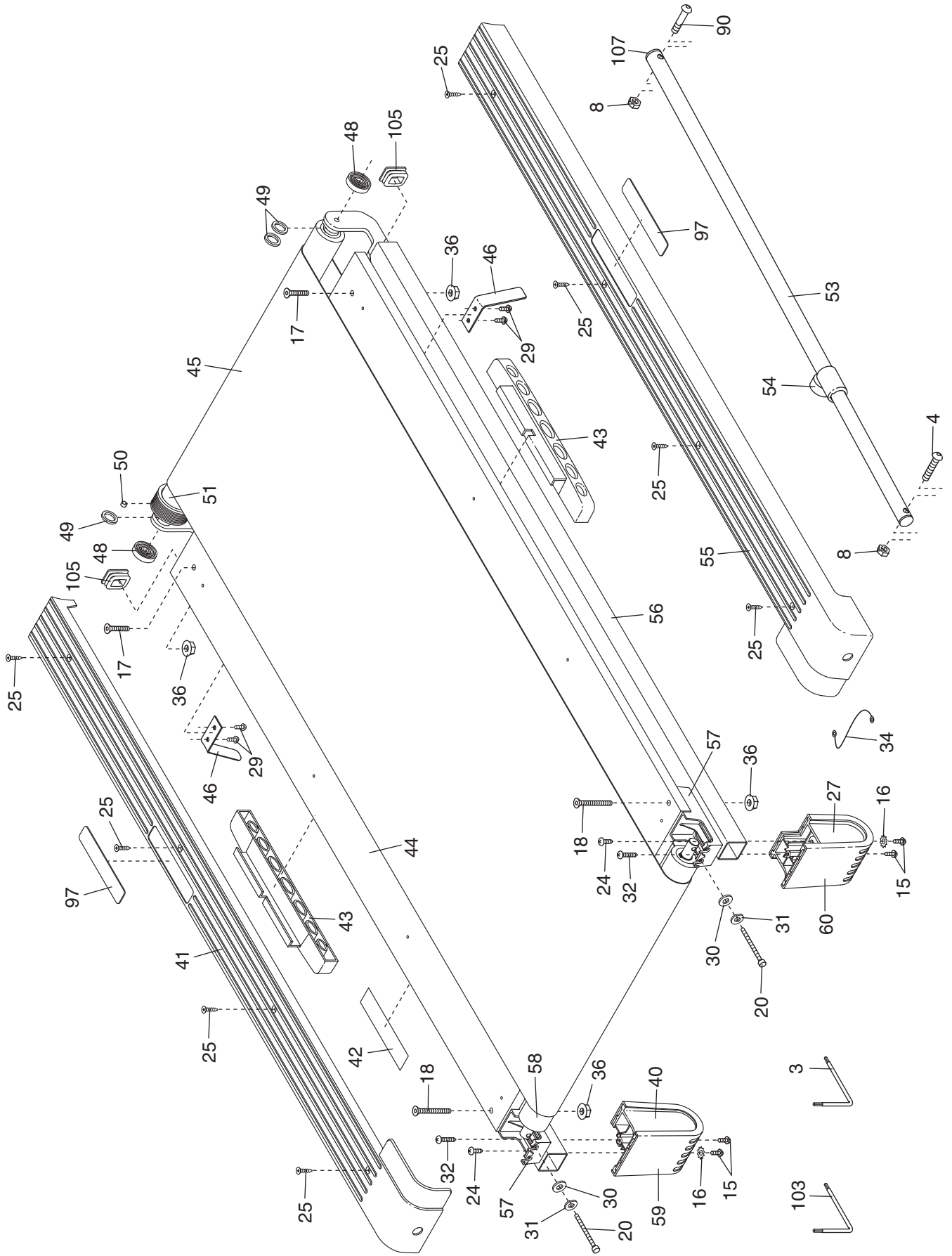

EXPLODED DRAWING B—Model No. PFTL79807.0

R1007A

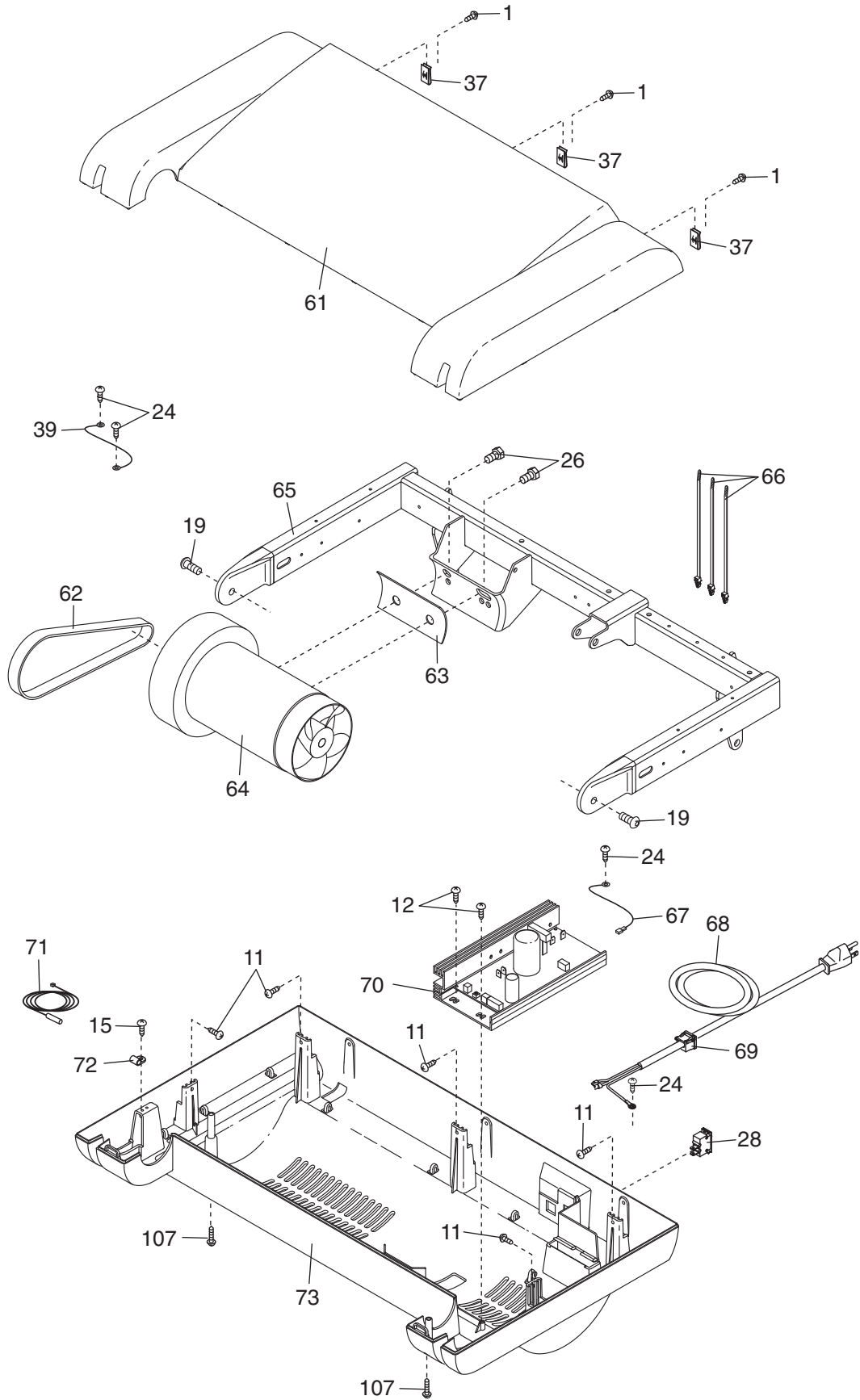

EXPLODED DRAWING D—Model No. PFTL79807.0

R1007A

