

EXPLODED DRAWING A

Model No. PFTL80016.3 R1217A

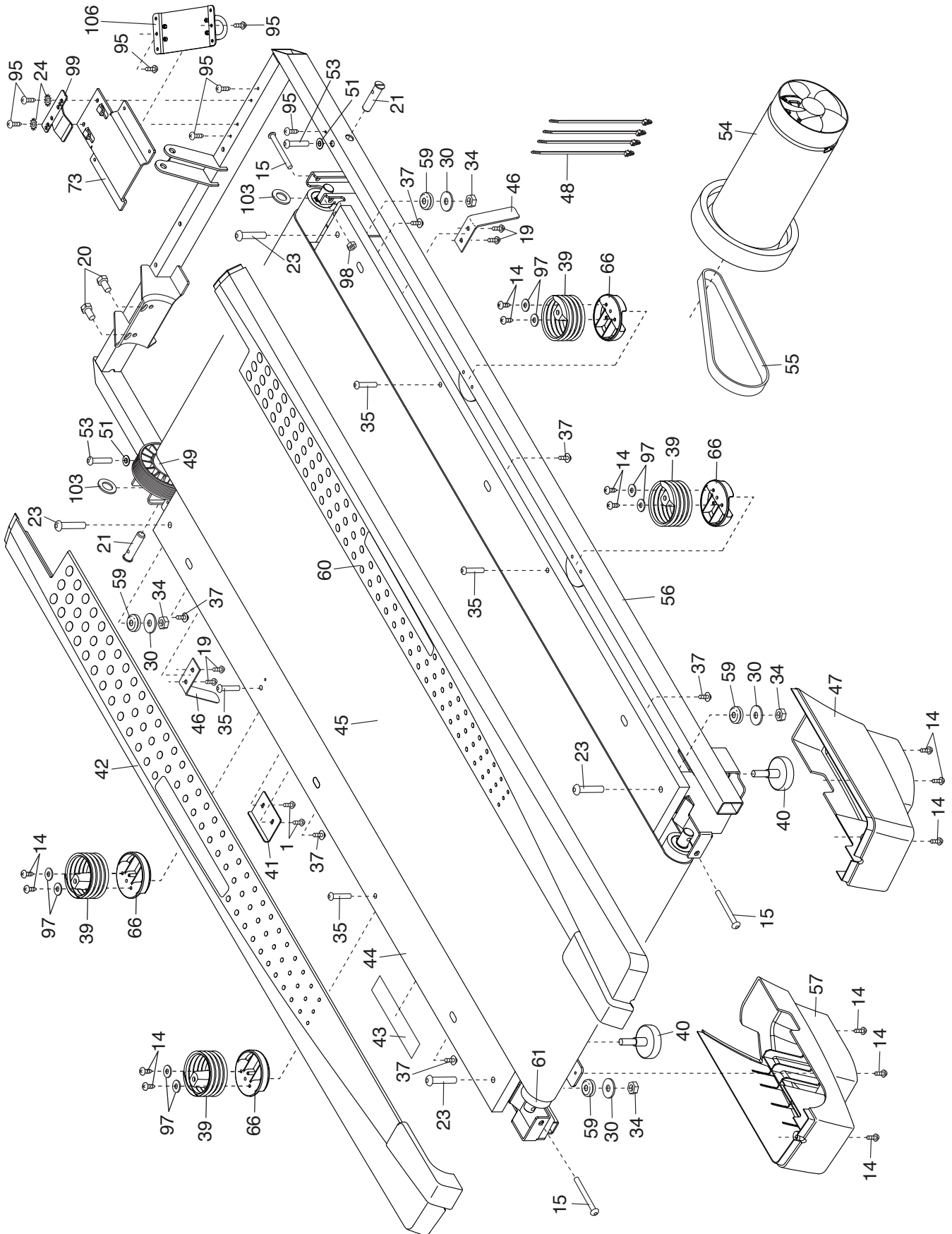

EXPLODED DRAWING B

Model No. PFTL80016.3 R1217A

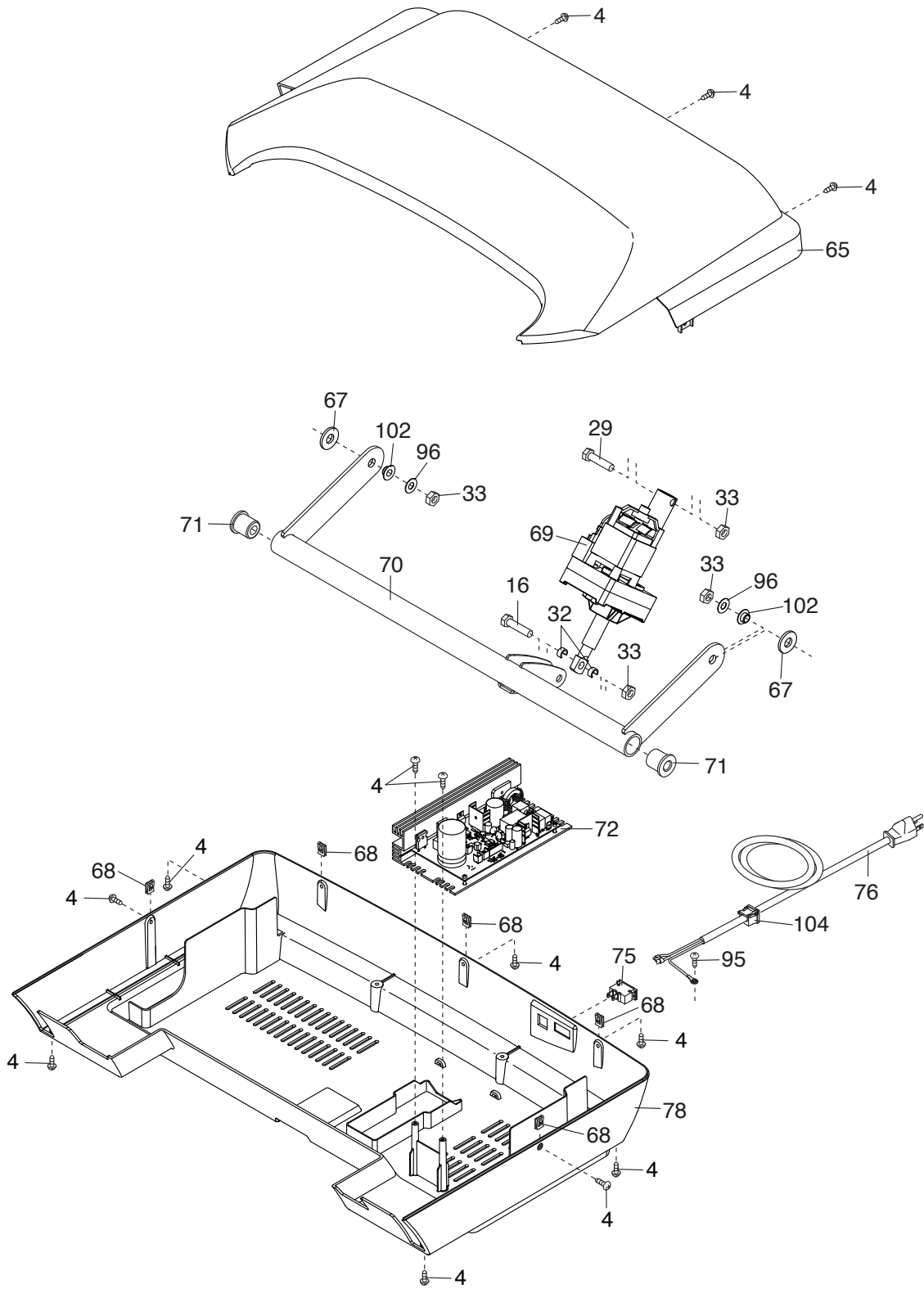

EXPLODED DRAWING C

Model No. PFTL80016.3 R1217A

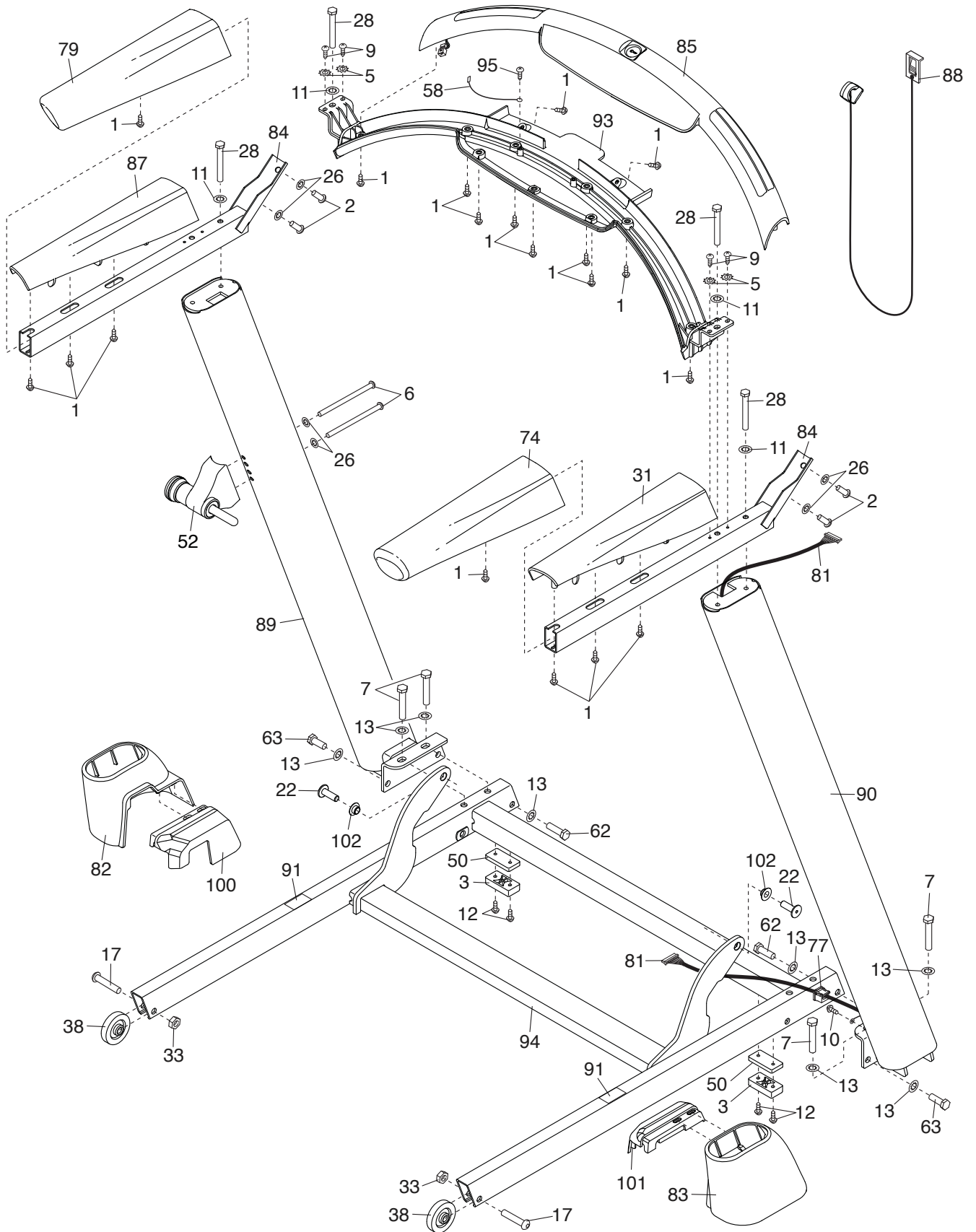

EXPLODED DRAWING D

Model No. PFTL80016.3 R1217A

