

EXPLODED DRAWING B

Model No. PFTL80916.0 R0816A

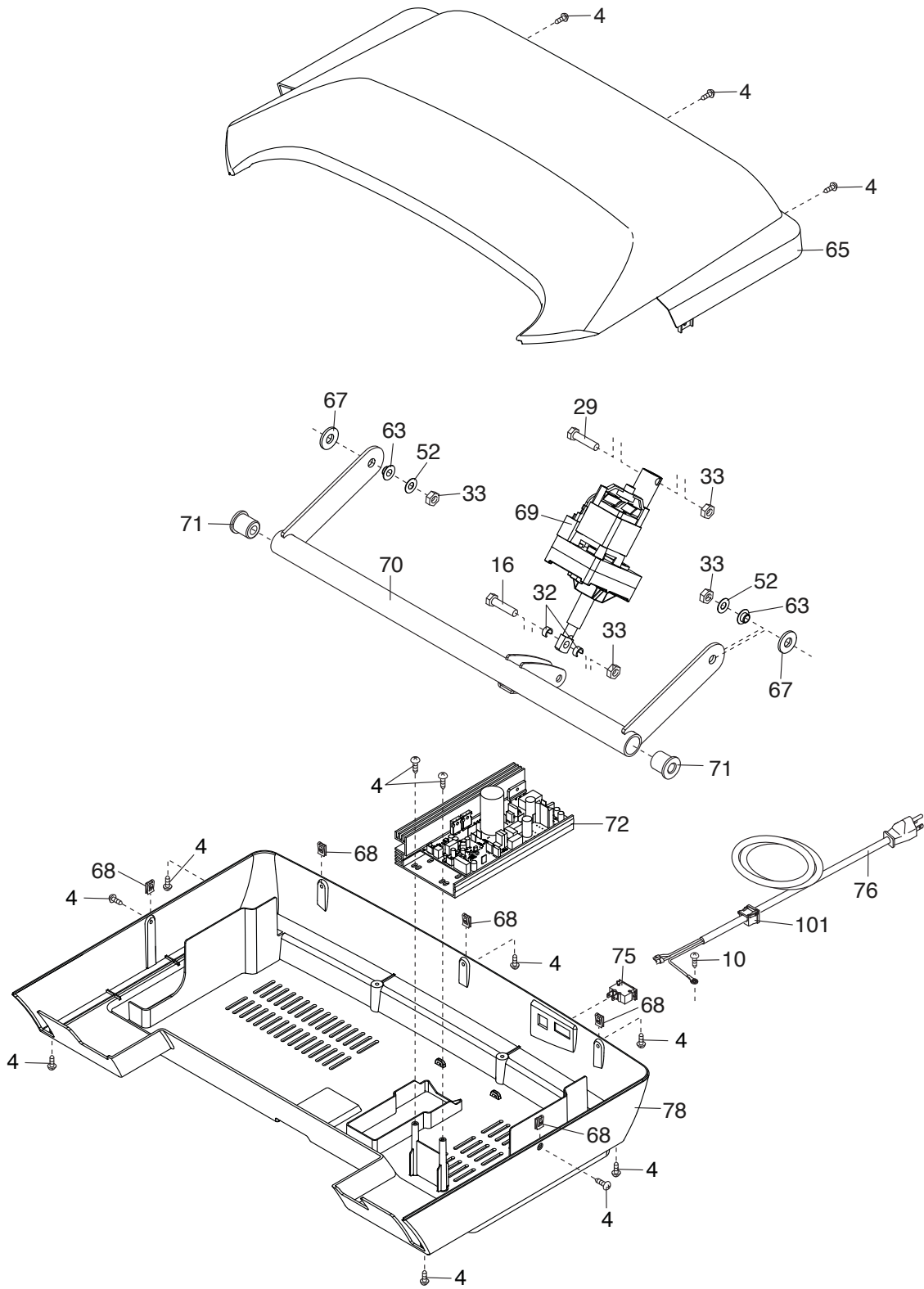

EXPLODED DRAWING C

Model No. PFTL80916.0 R0816A

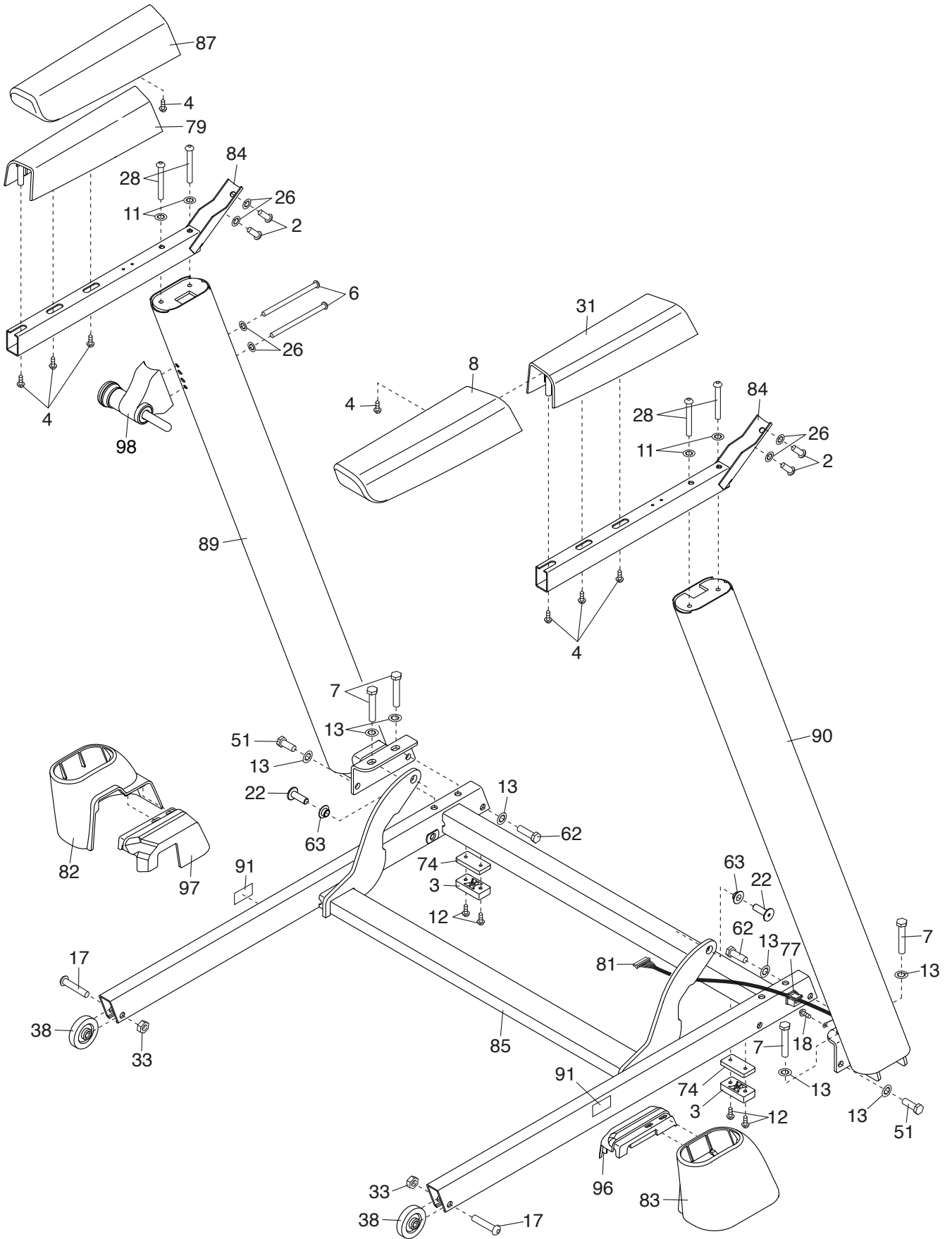

EXPLODED DRAWING D

Model No. PFTL80916.0 R0816A

