

EXPLODED DRAWING A—Model No. PFTL81910.0

R1010A

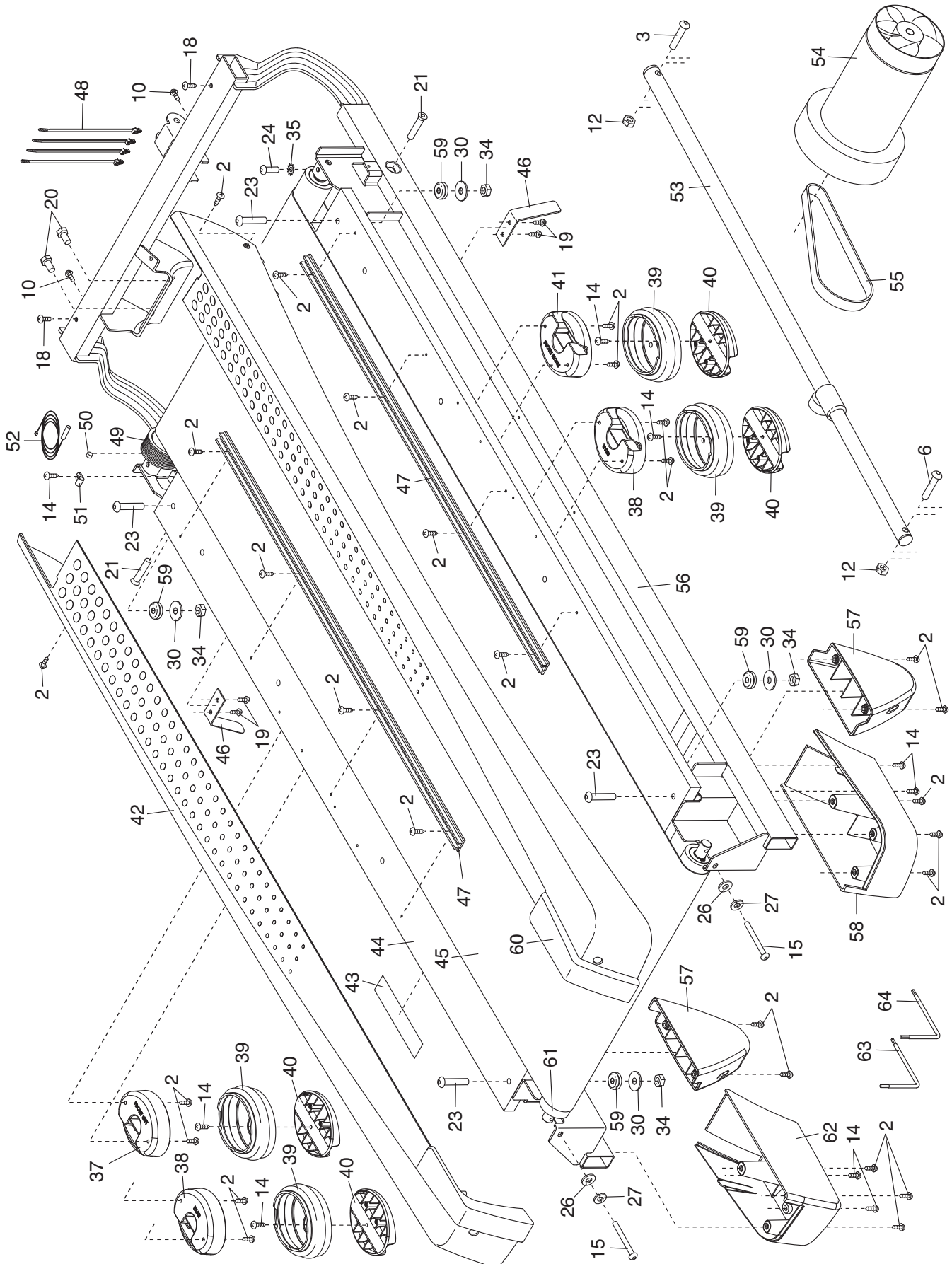

EXPLODED DRAWING B—Model No. PFTL81910.0

R1010A

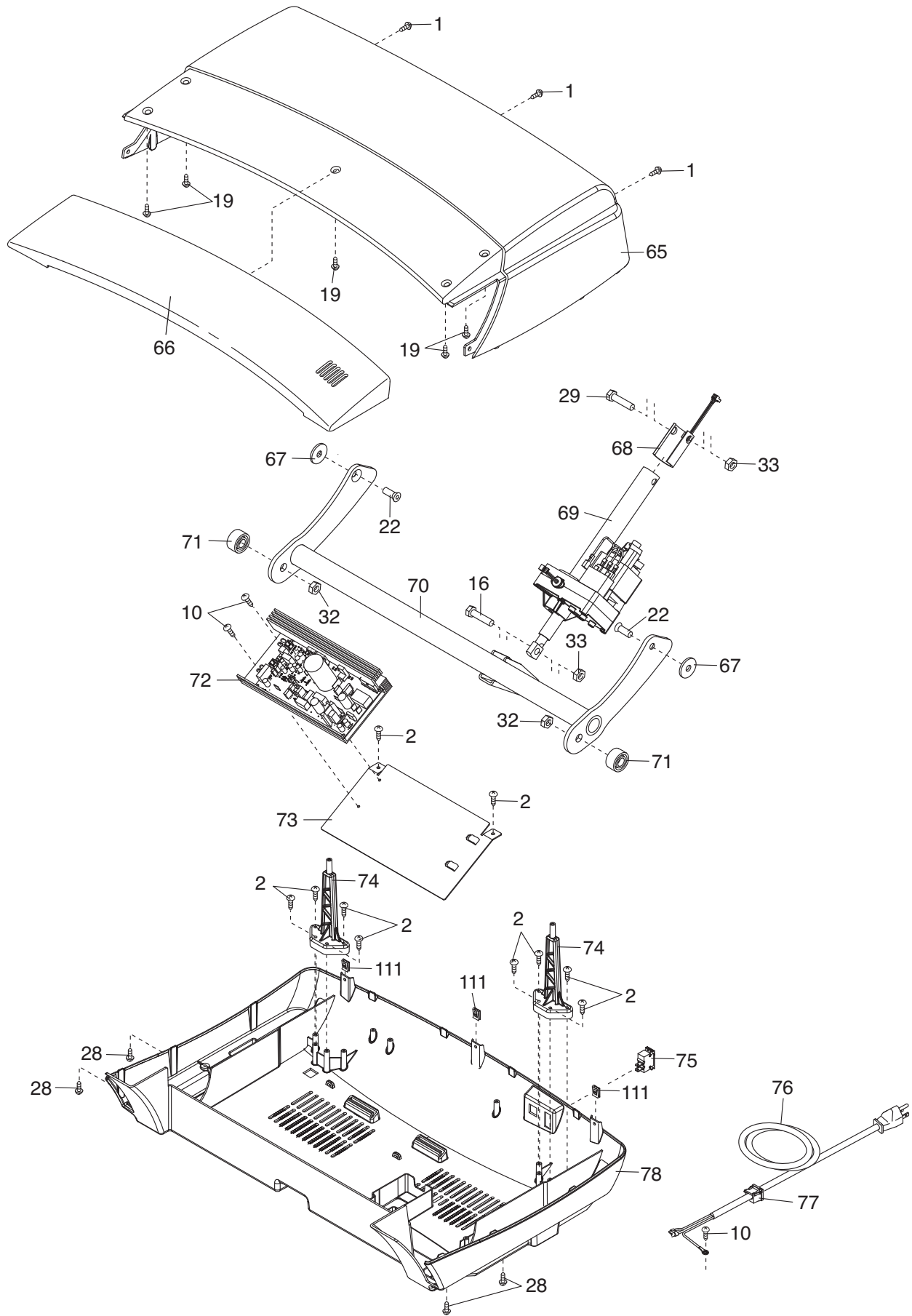

EXPLODED DRAWING C—Model No. PFTL81910.0

R1010A

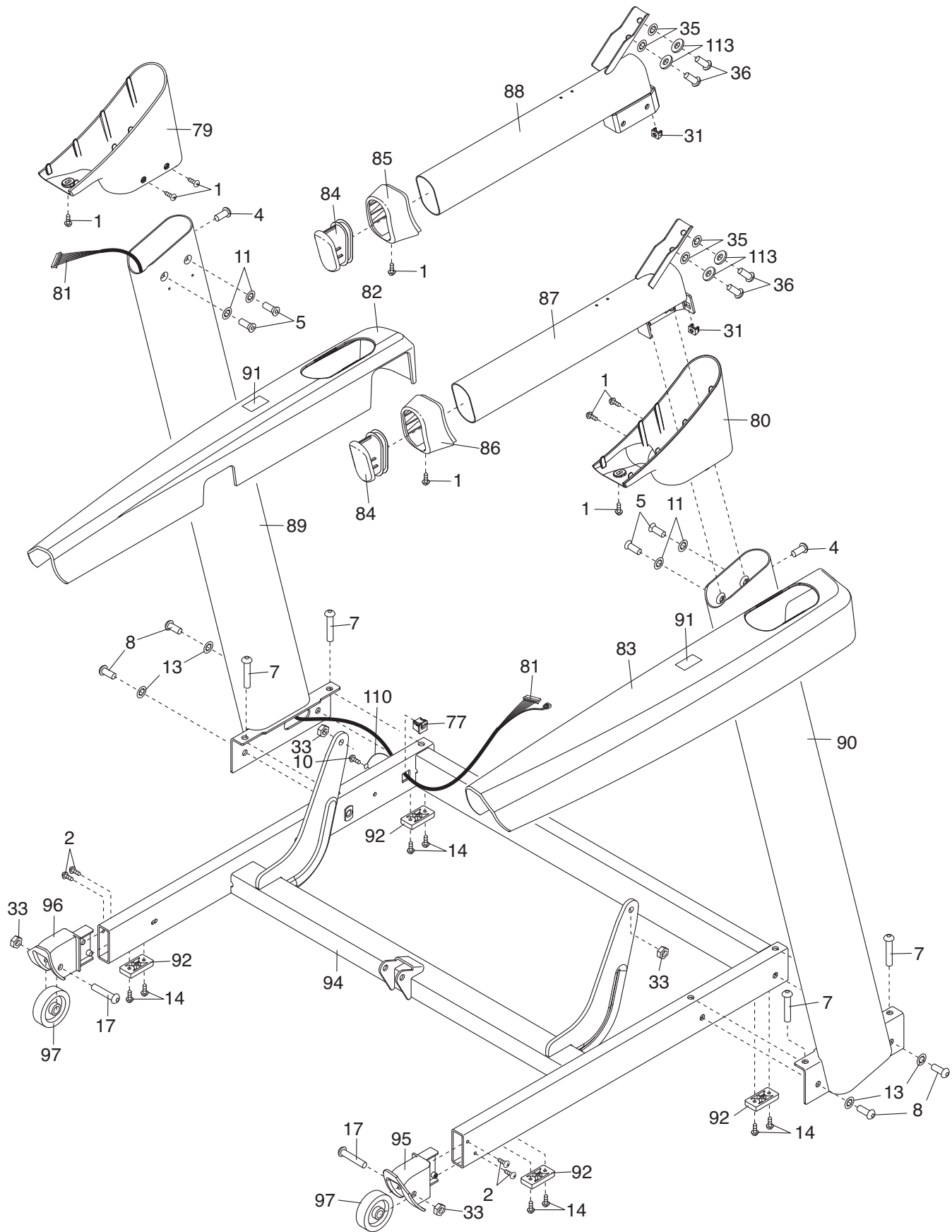

EXPLODED DRAWING D—Model No. PFTL81910.0

R1010A

