

EXPLODED DRAWING A—Model No. PFTL87706.1

R1207A

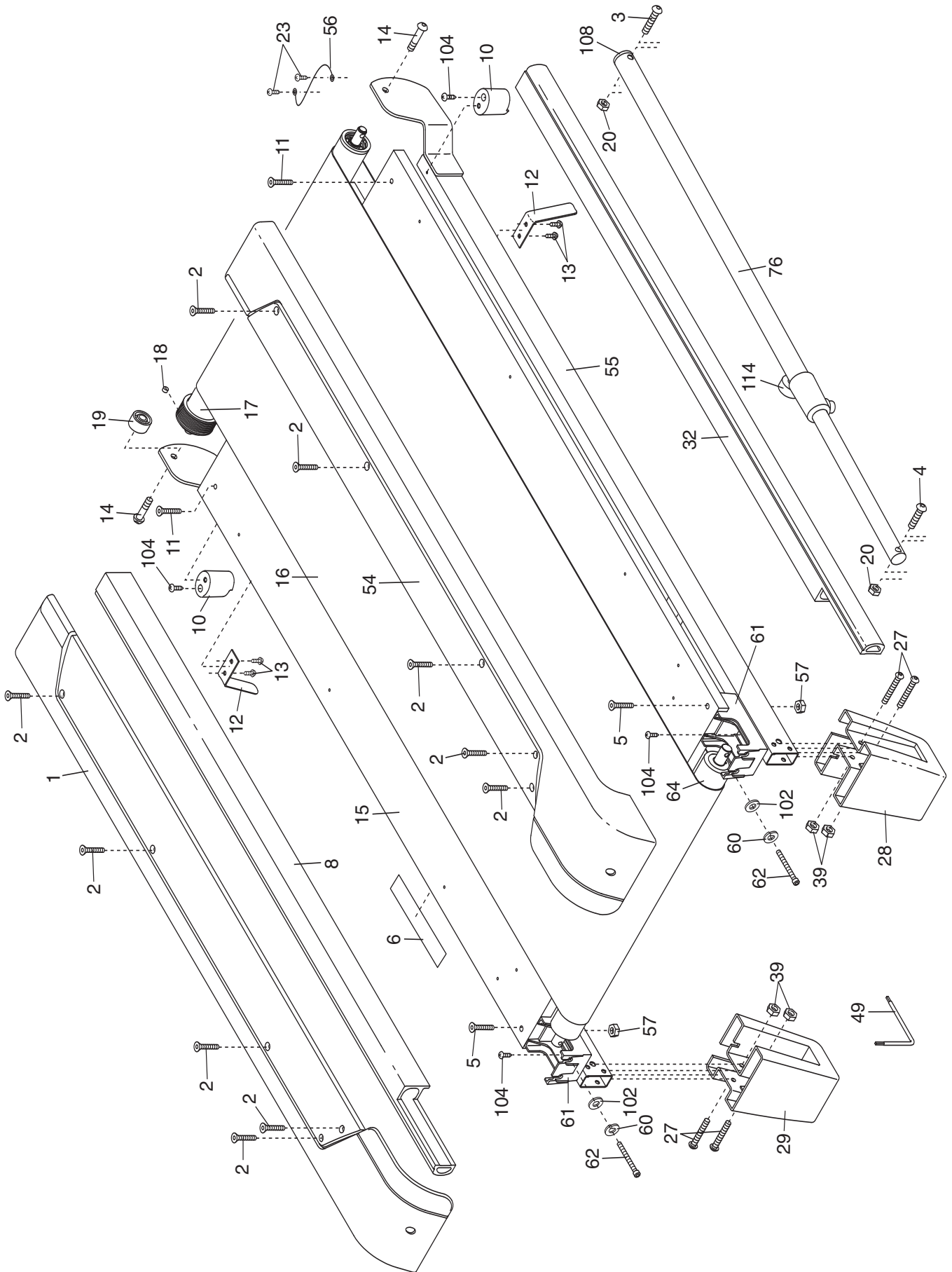

EXPLODED DRAWING C—Model No. PFTL87706.1

R1207A

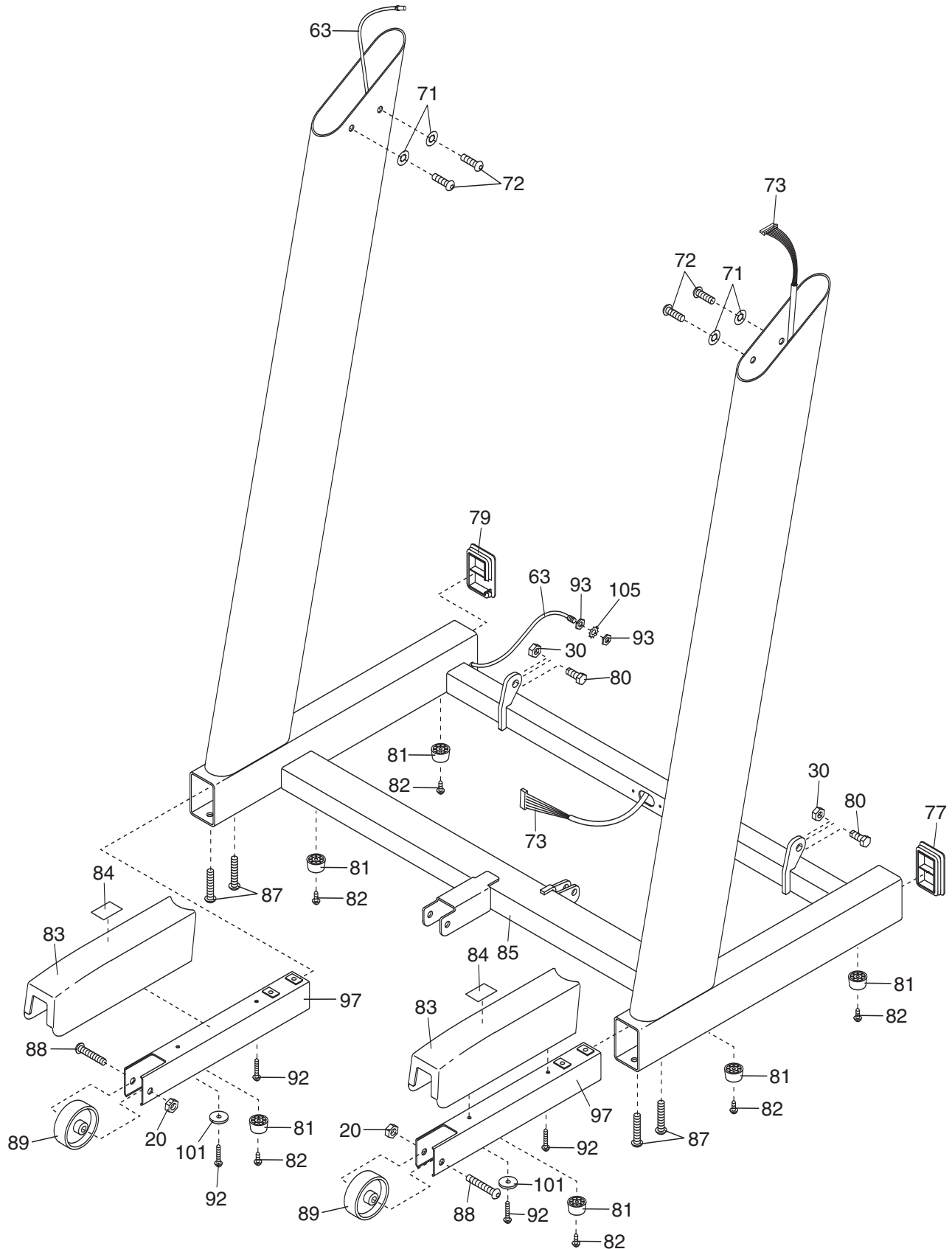

EXPLODED DRAWING D—Model No. PFTL87706.1

R1207A

