

# EXPLODED DRAWING A—Model No. PFTL87706.0

R0107A

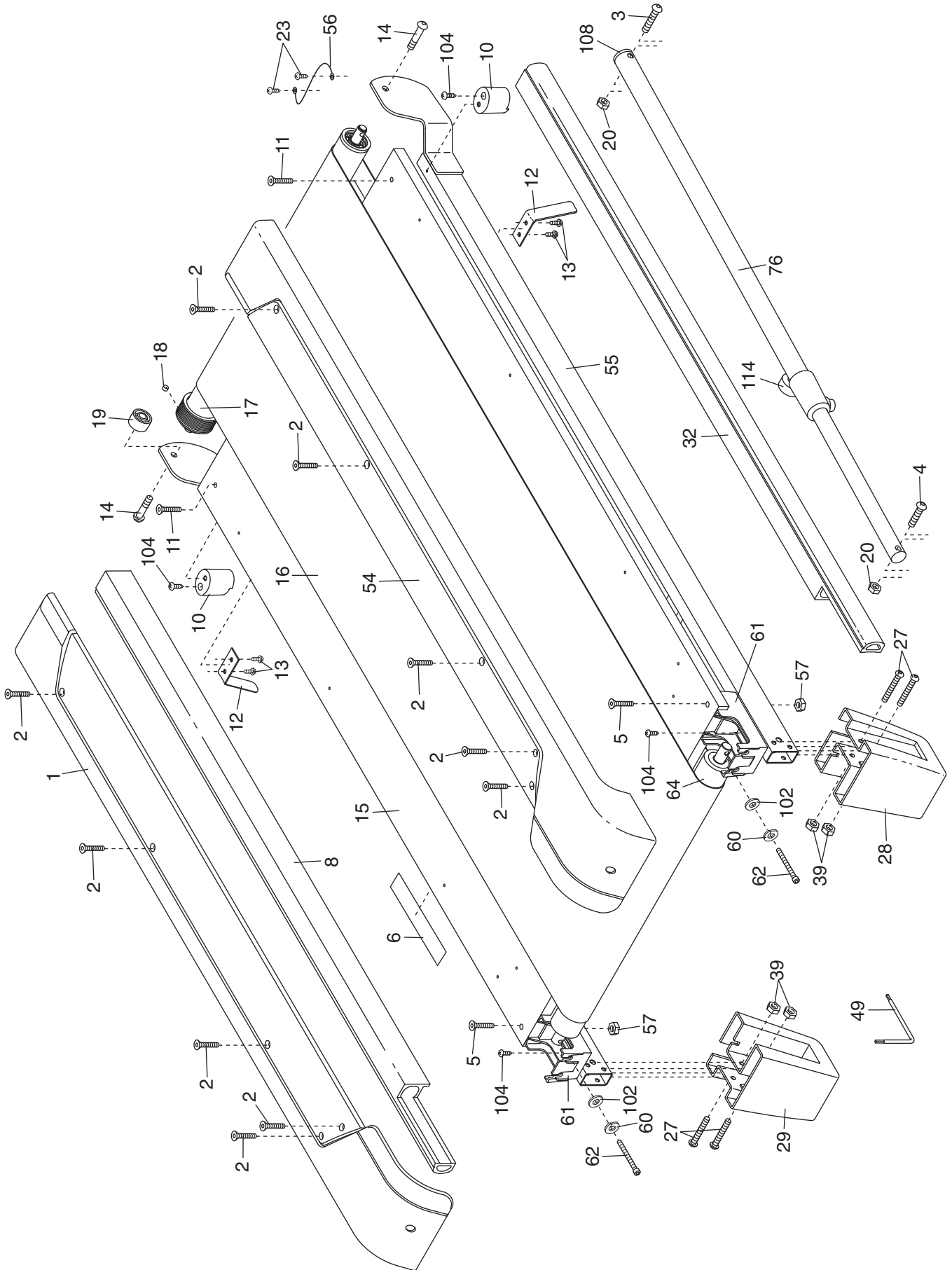

# EXPLODED DRAWING B—Model No. PFTL87706.0

R0107A

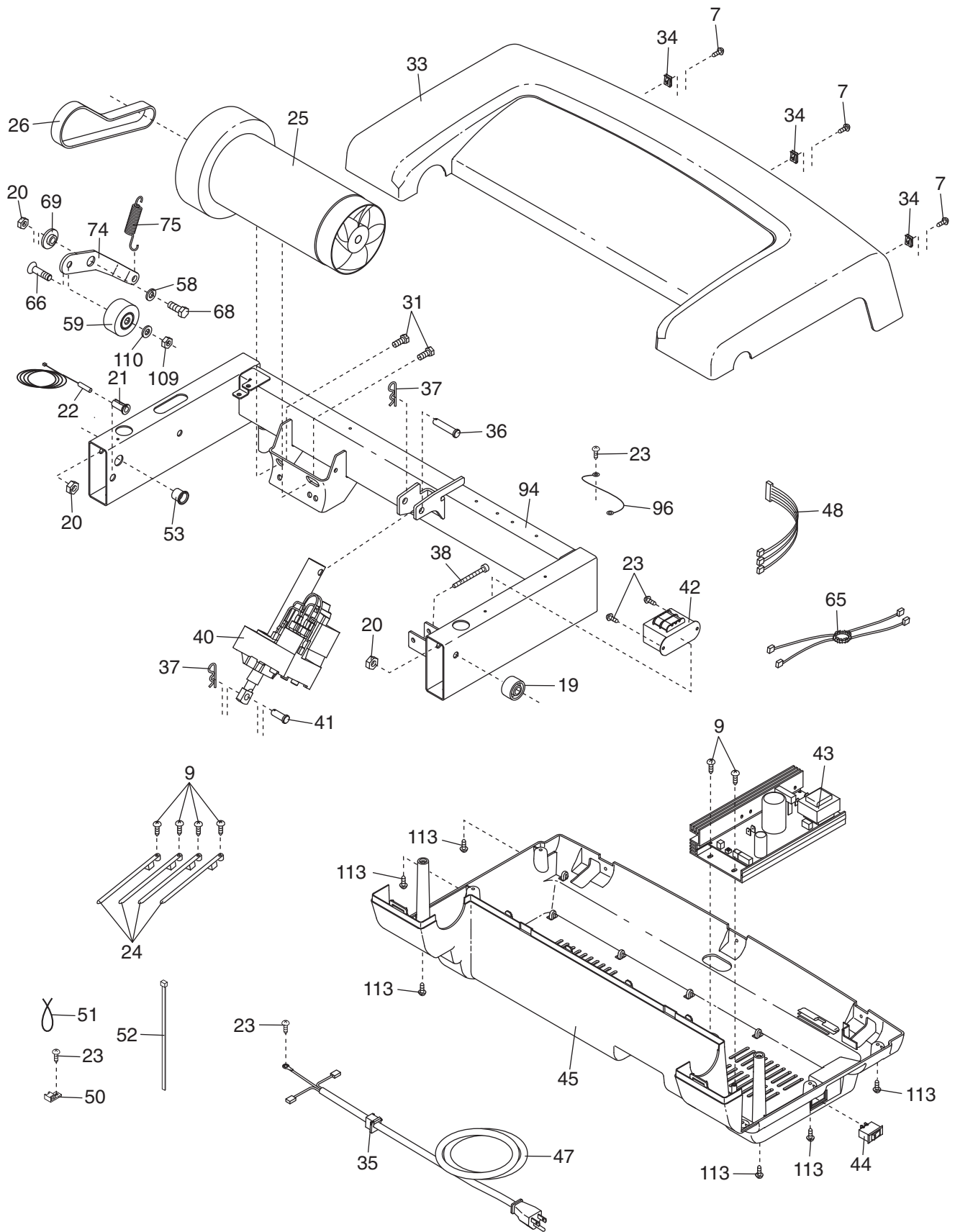

# EXPLODED DRAWING C—Model No. PFTL87706.0

R0107A

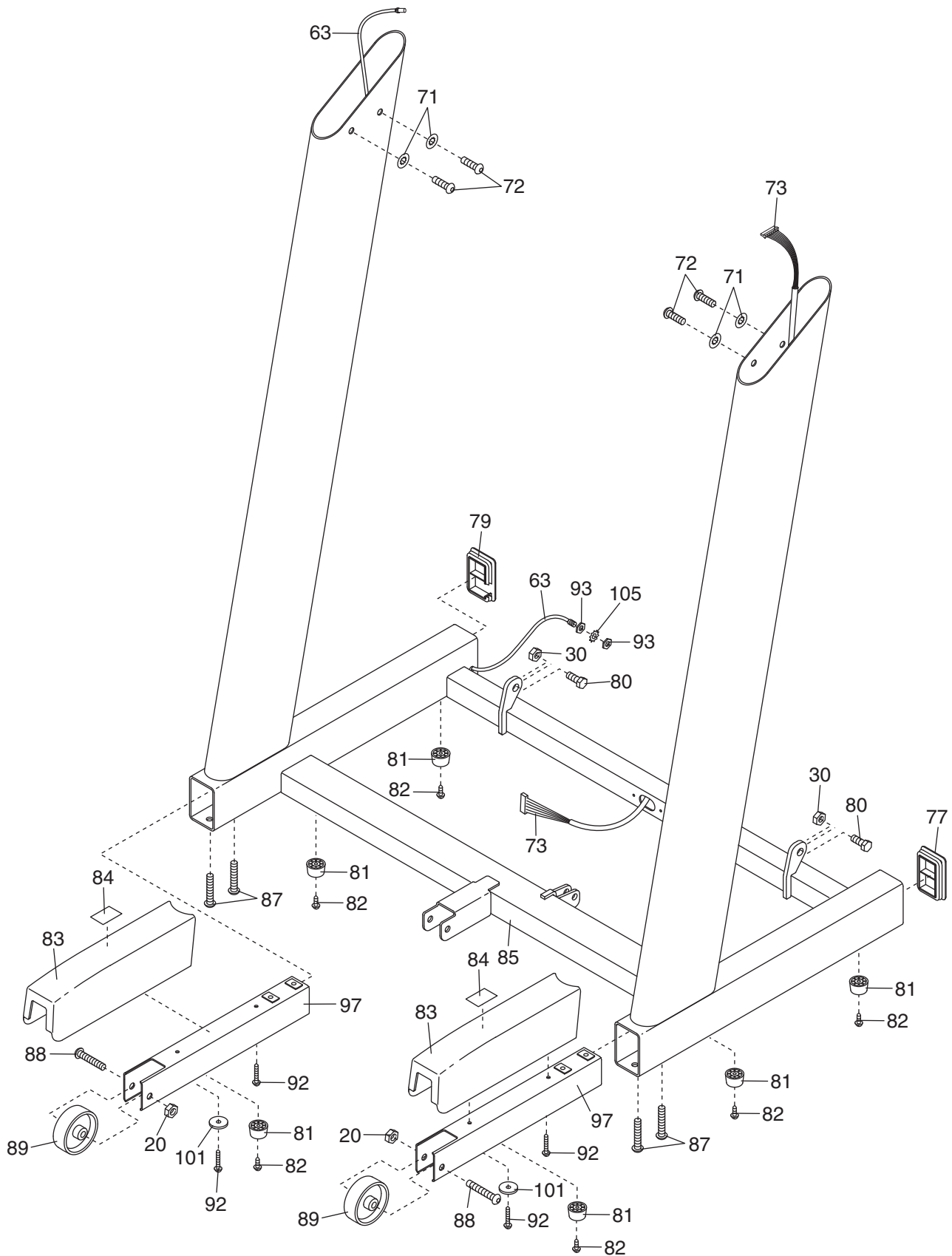

# EXPLODED DRAWING D—Model No. PFTL87706.0

R0107A

