

# EXPLODED DRAWING A

Model No. PFTL89015.0 R0915A

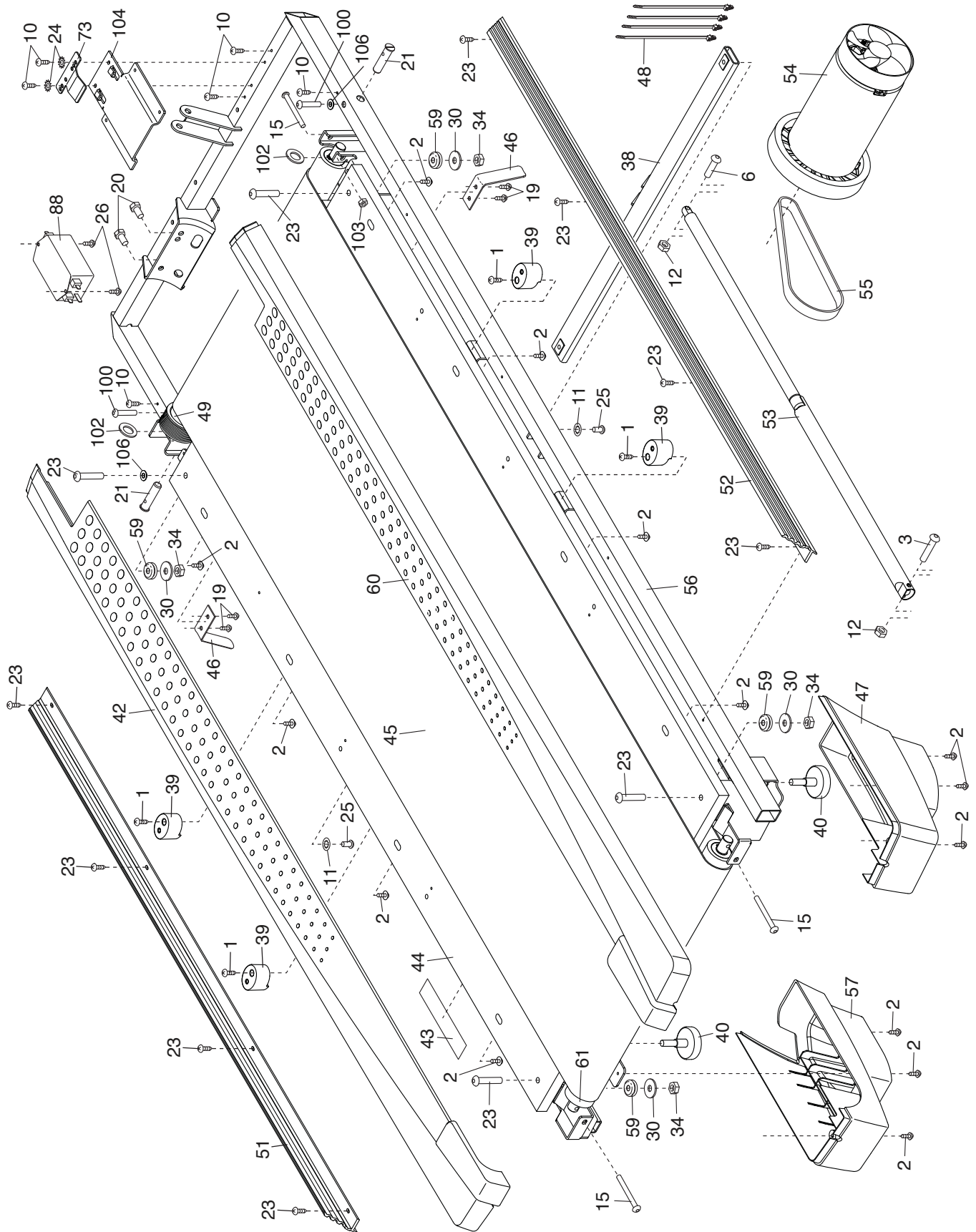

# EXPLODED DRAWING B

Model No. PFTL89015.0 R0915A

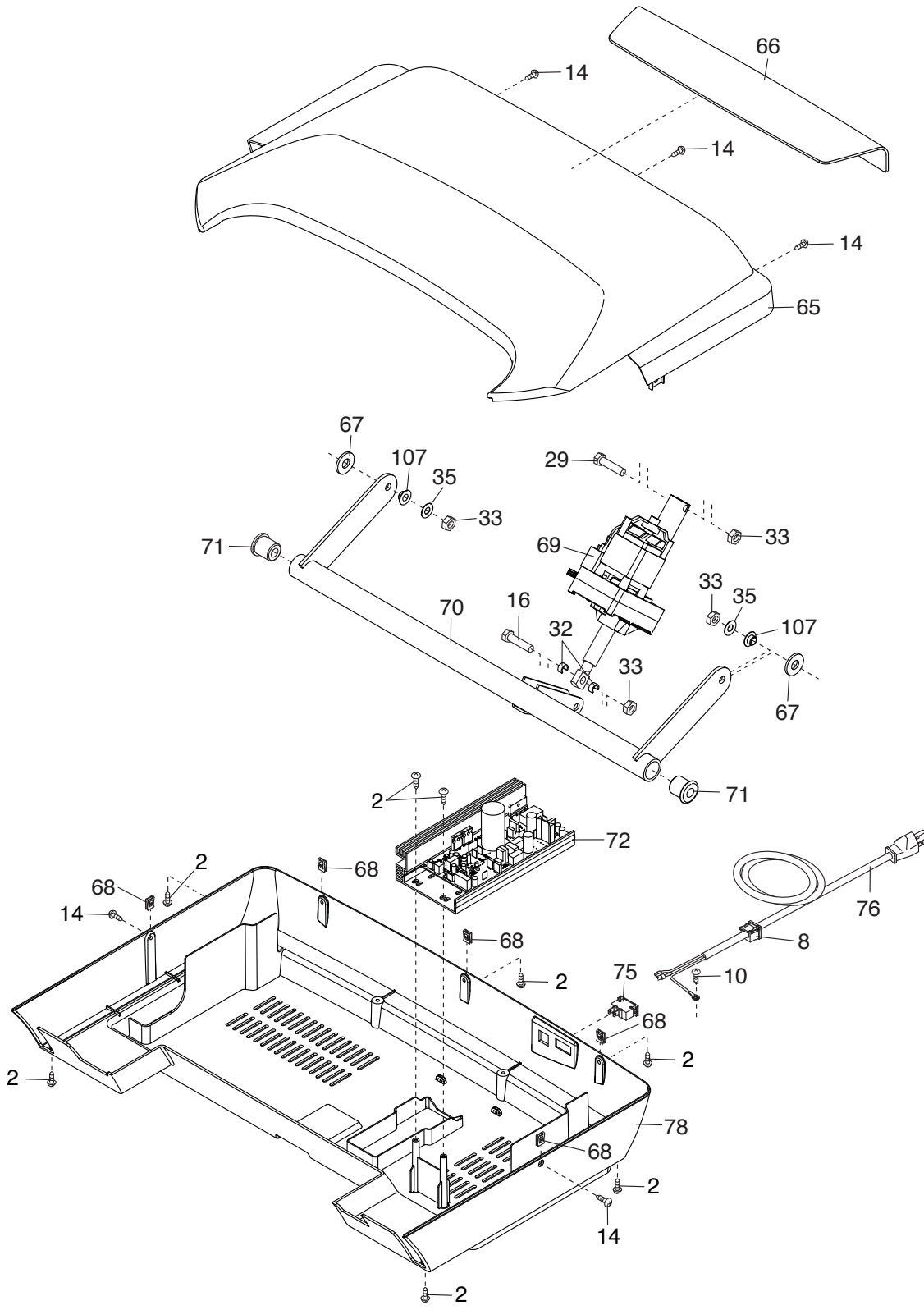

# EXPLODED DRAWING C

Model No. PFTL89015.0 R0915A

