

# EXPLODED DRAWING A

Model No. PFTL89017.1 R1017B

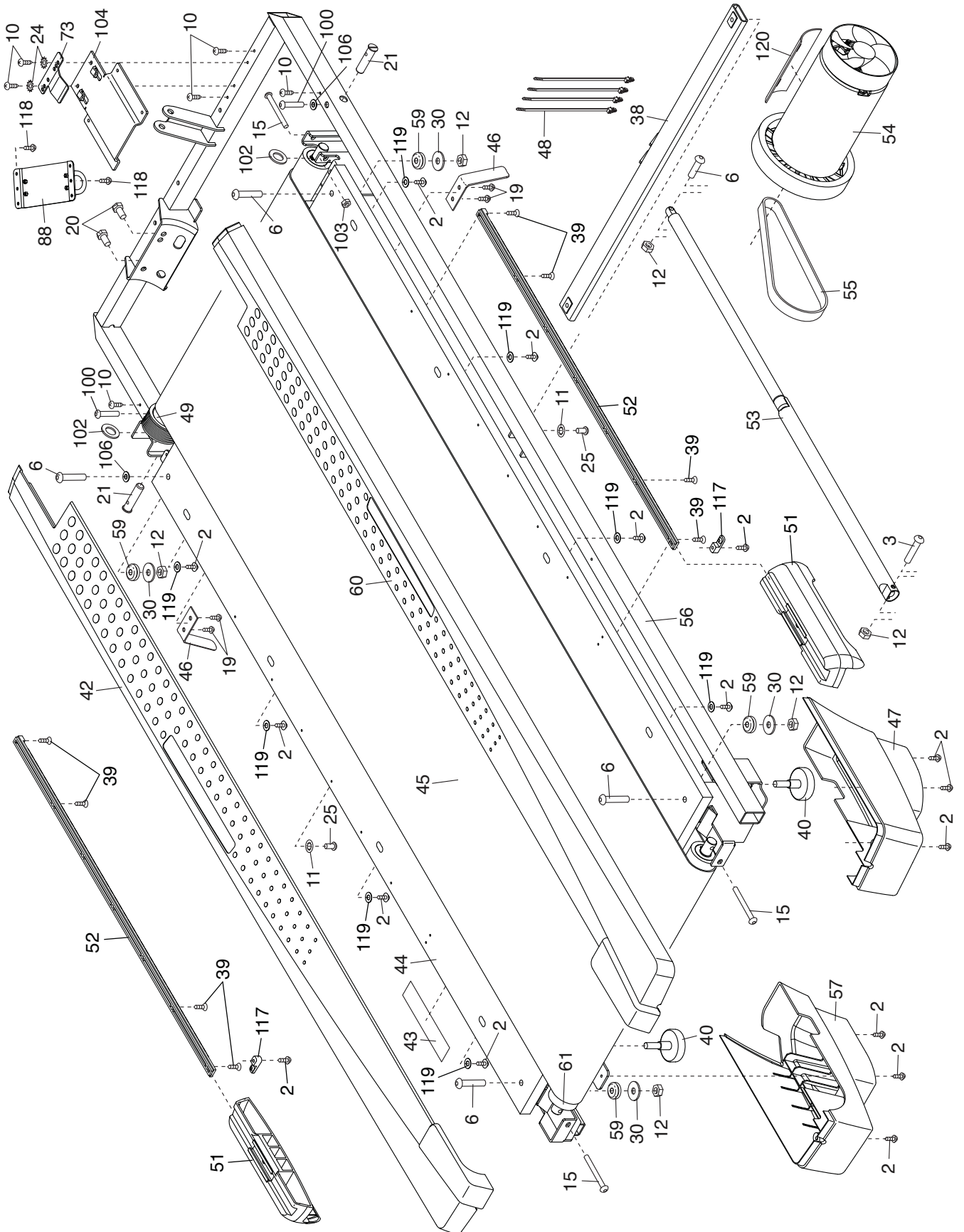

# EXPLODED DRAWING B

Model No. PFTL89017.1 R1017B

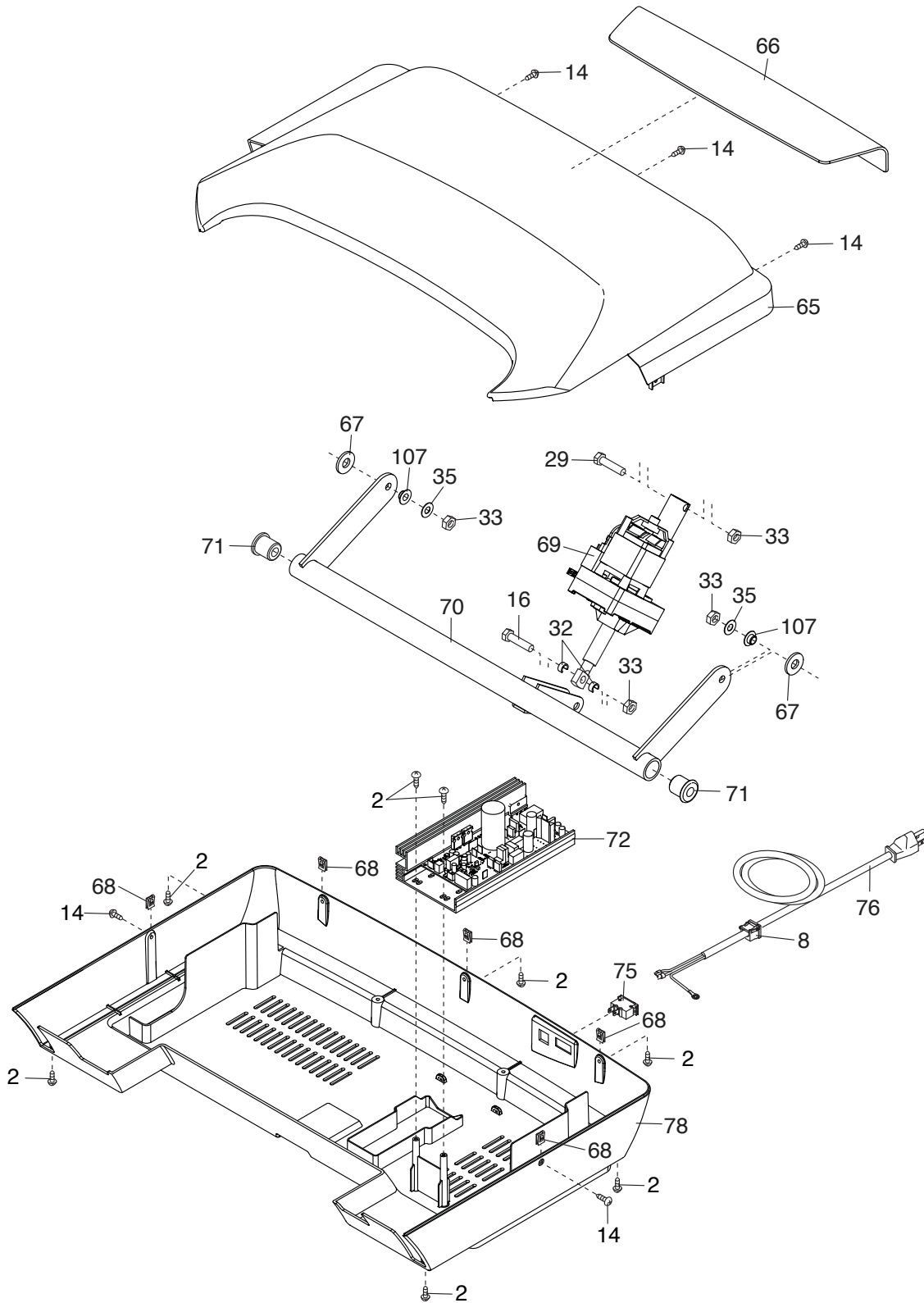

# EXPLODED DRAWING C

Model No. PFTL89017.1 R1017B

