

EXPLODED DRAWING A

Model No. PFTL89017.3 R0520A

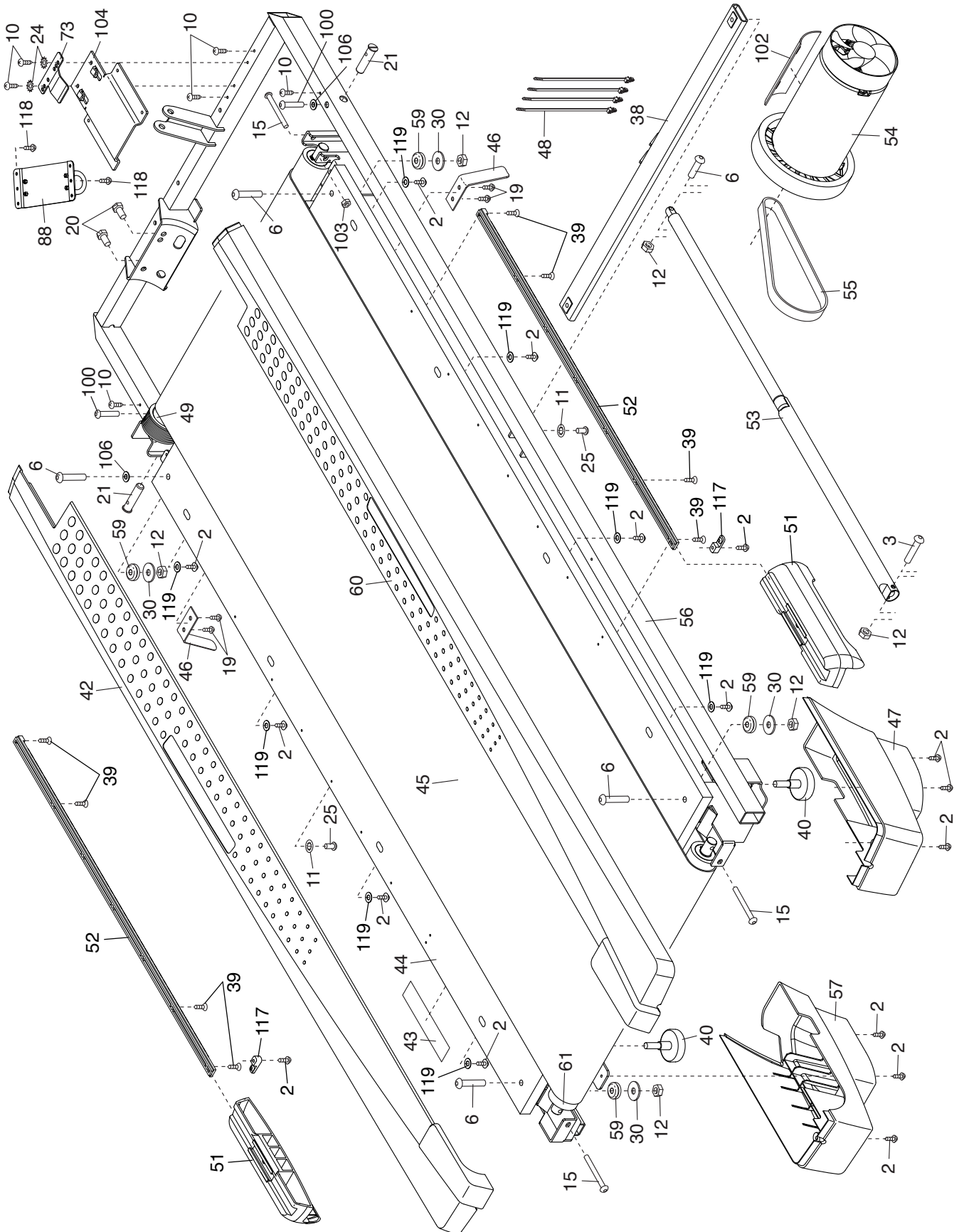

EXPLODED DRAWING B

Model No. PFTL89017.3 R0520A

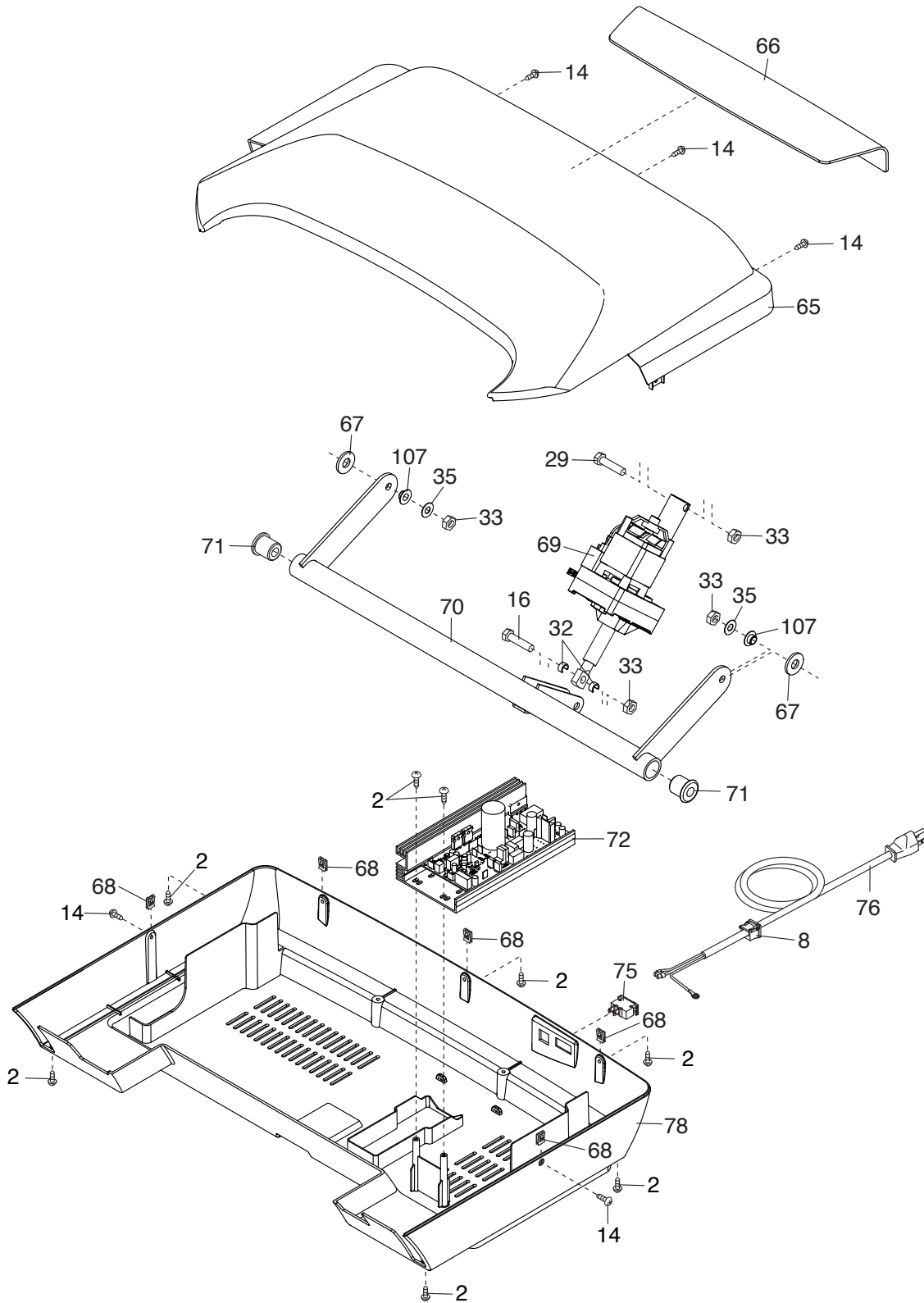

EXPLODED DRAWING D

Model No. PFTL89017.3 R0520A

