

# EXPLODED DRAWING A

Model No. PFTL89515.0 R0316A

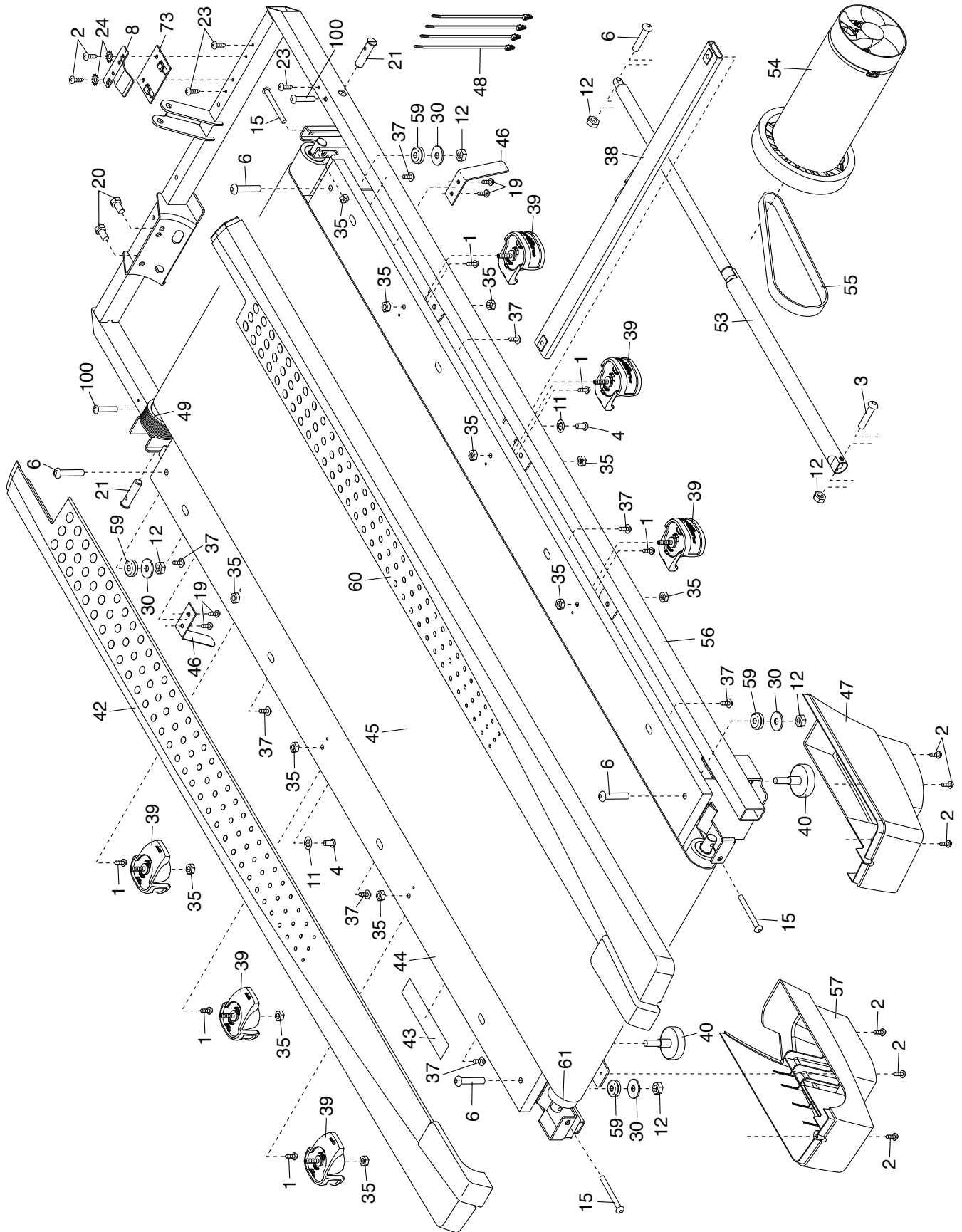

# EXPLODED DRAWING B

Model No. PFTL89515.0 R0316A

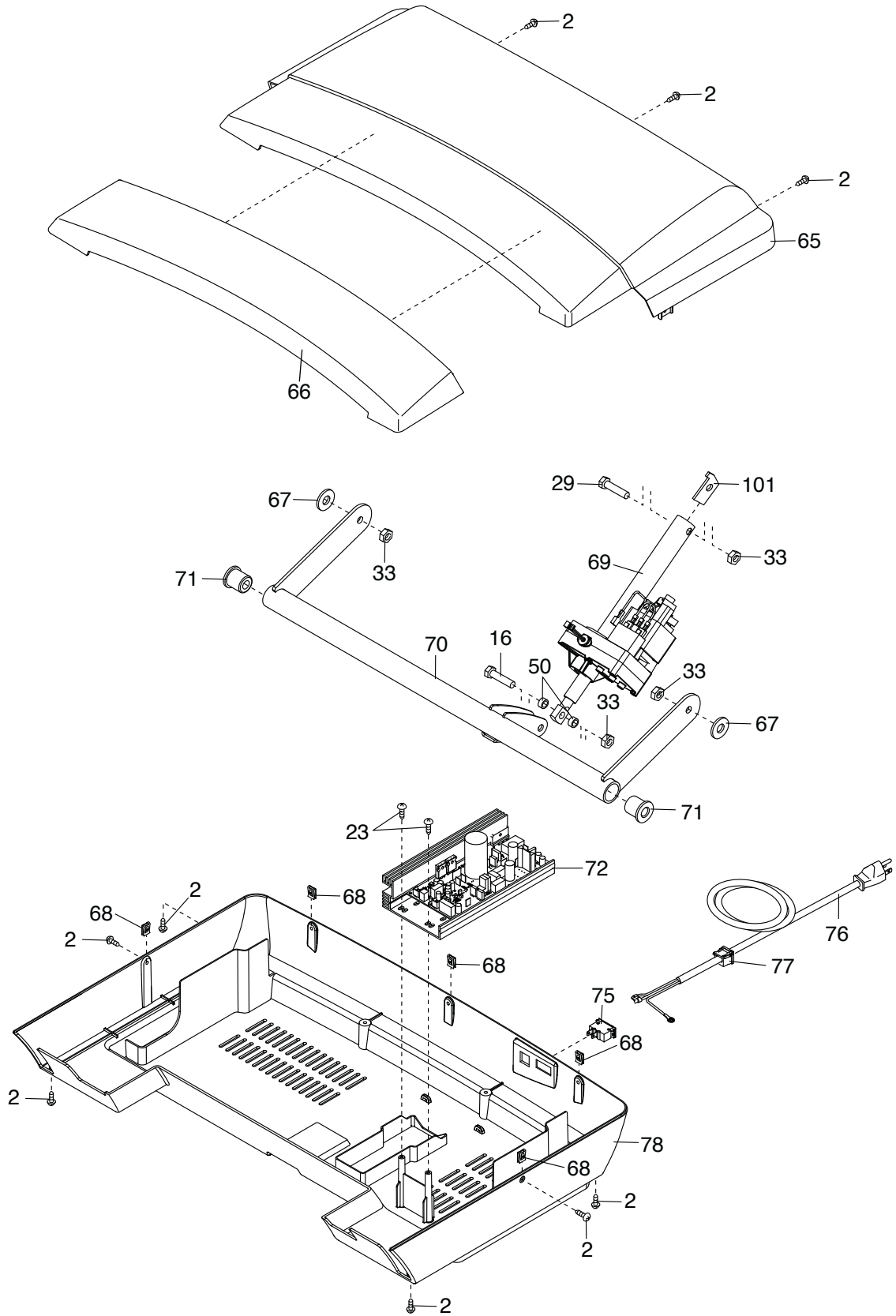

# EXPLODED DRAWING C

Model No. PFTL89515.0 R0316A

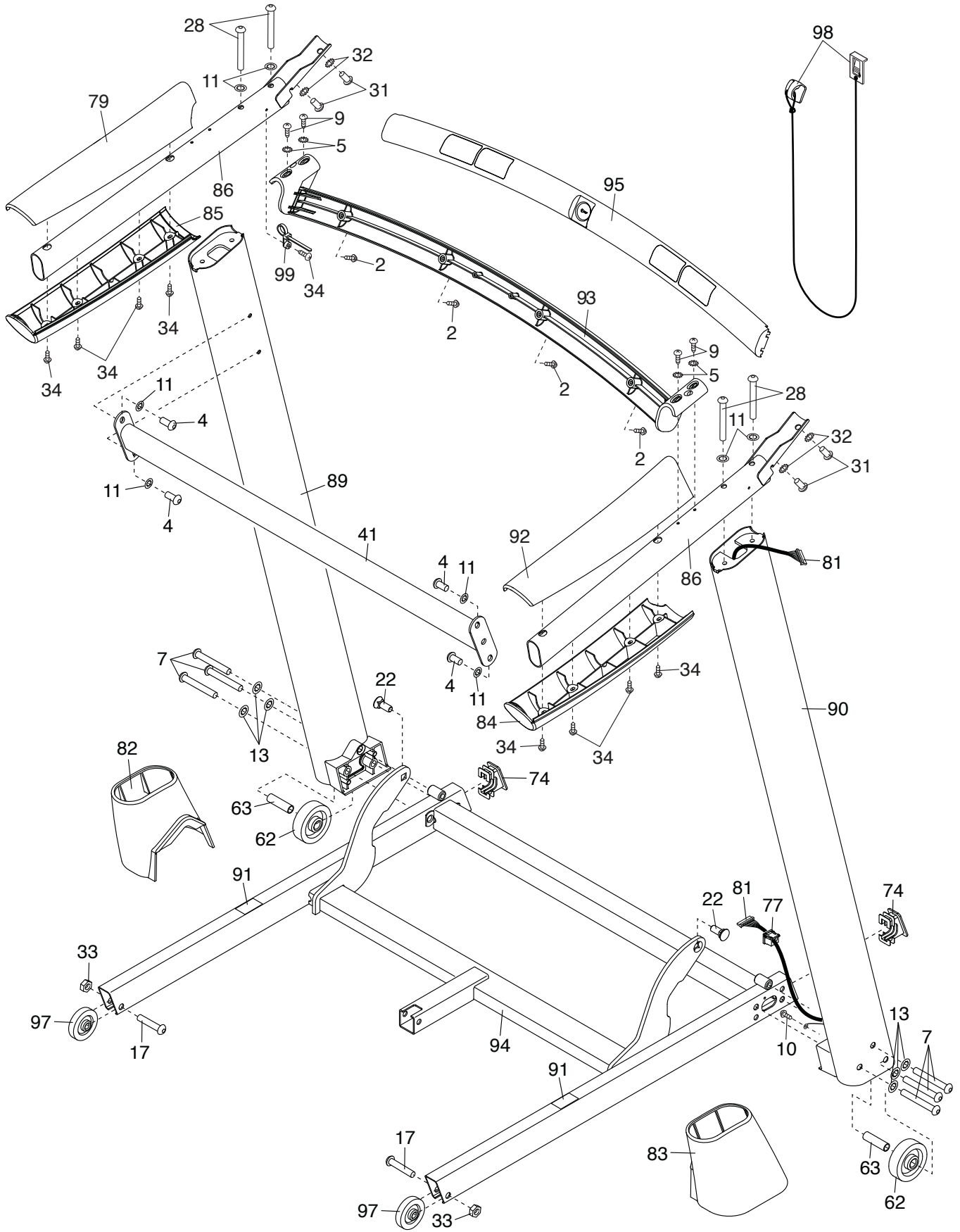

# EXPLODED DRAWING D

Model No. PFTL89515.0 R0316A

