

EXPLODED DRAWING A

Model No. PFTL90924.1 R0723A

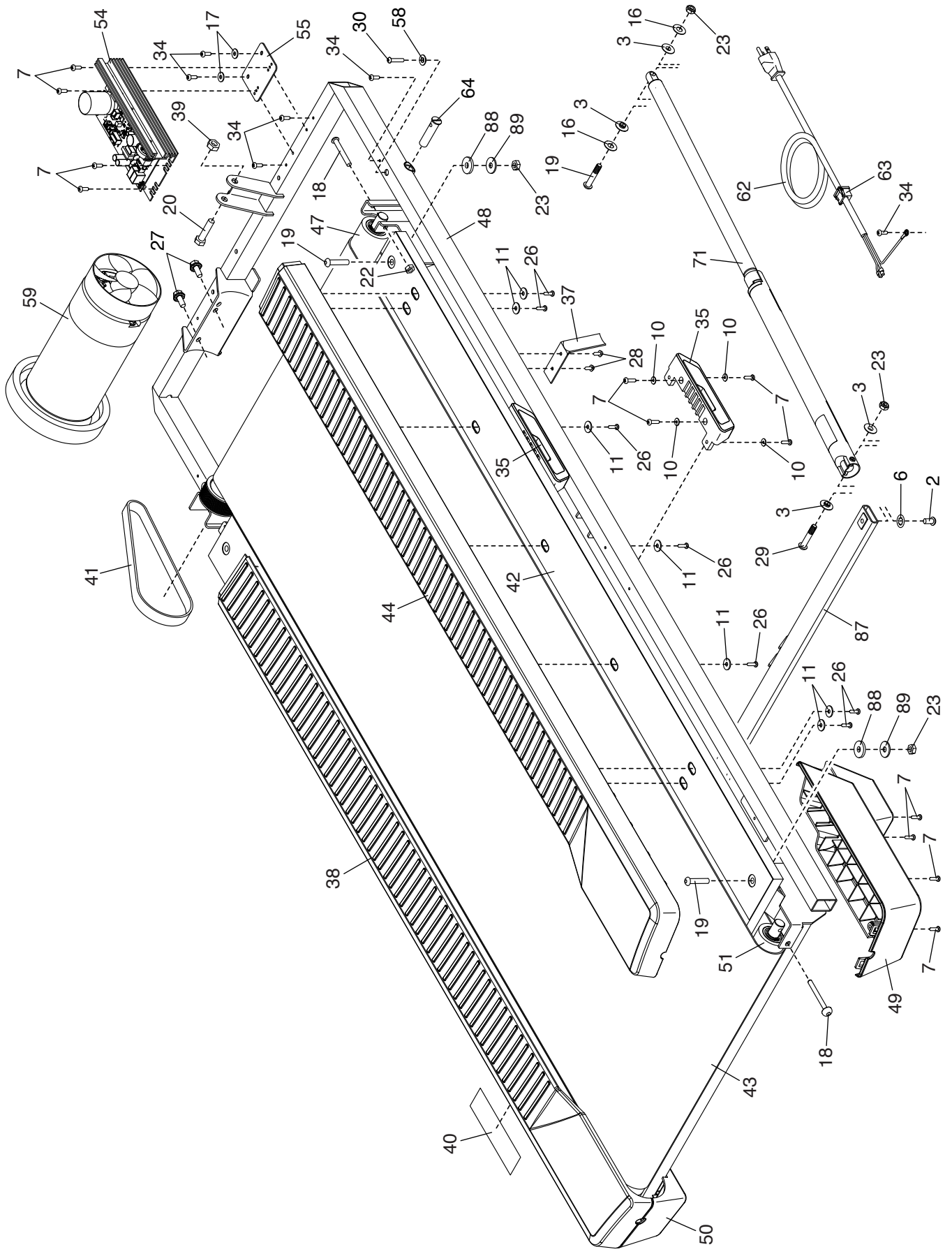

EXPLODED DRAWING B

Model No. PFTL90924.1 R0723A

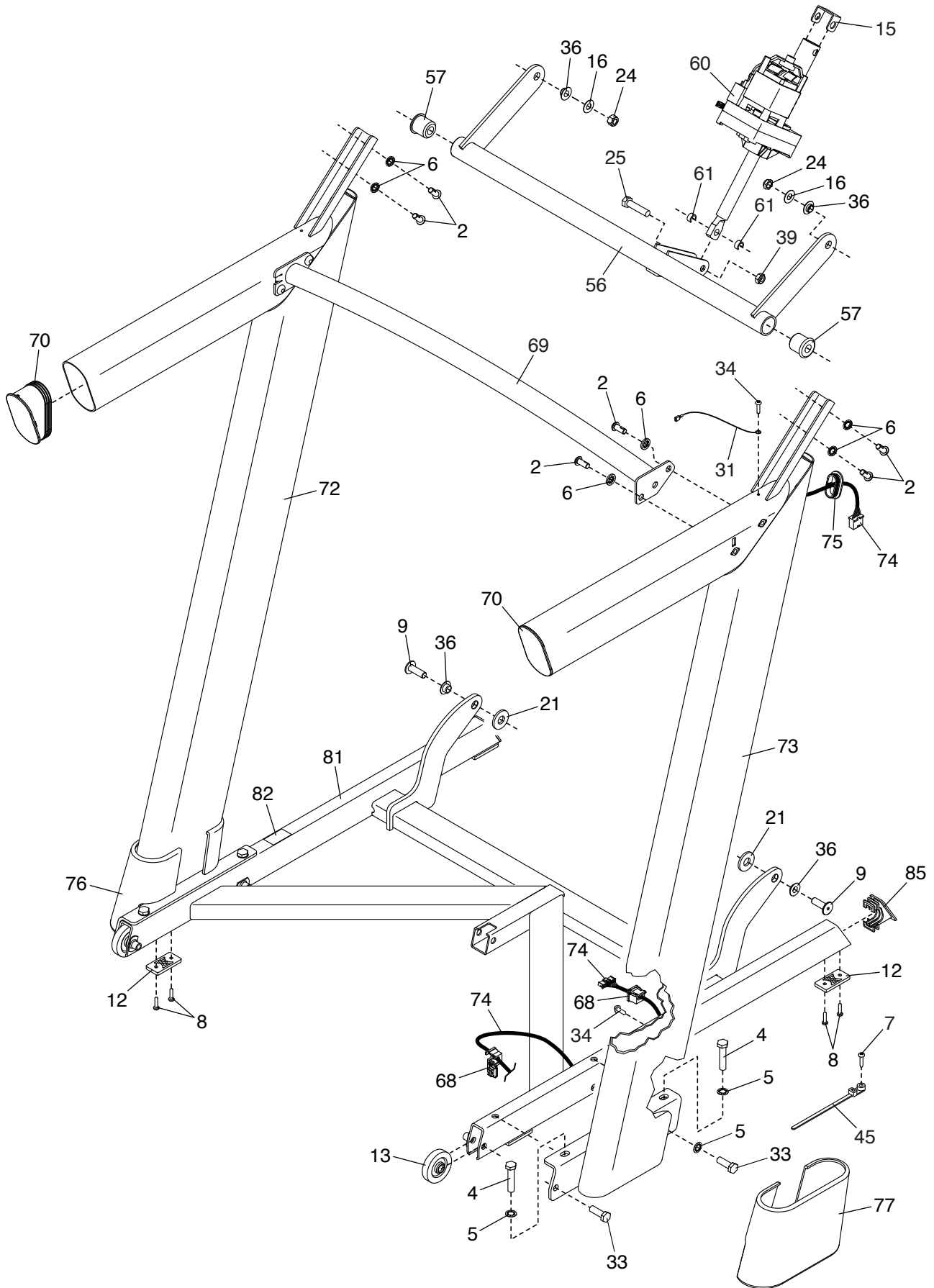

EXPLODED DRAWING C

Model No. PFTL90924.1 R0723A

