

EXPLODED DRAWING—Model No. PFTL91105.0

R0506A

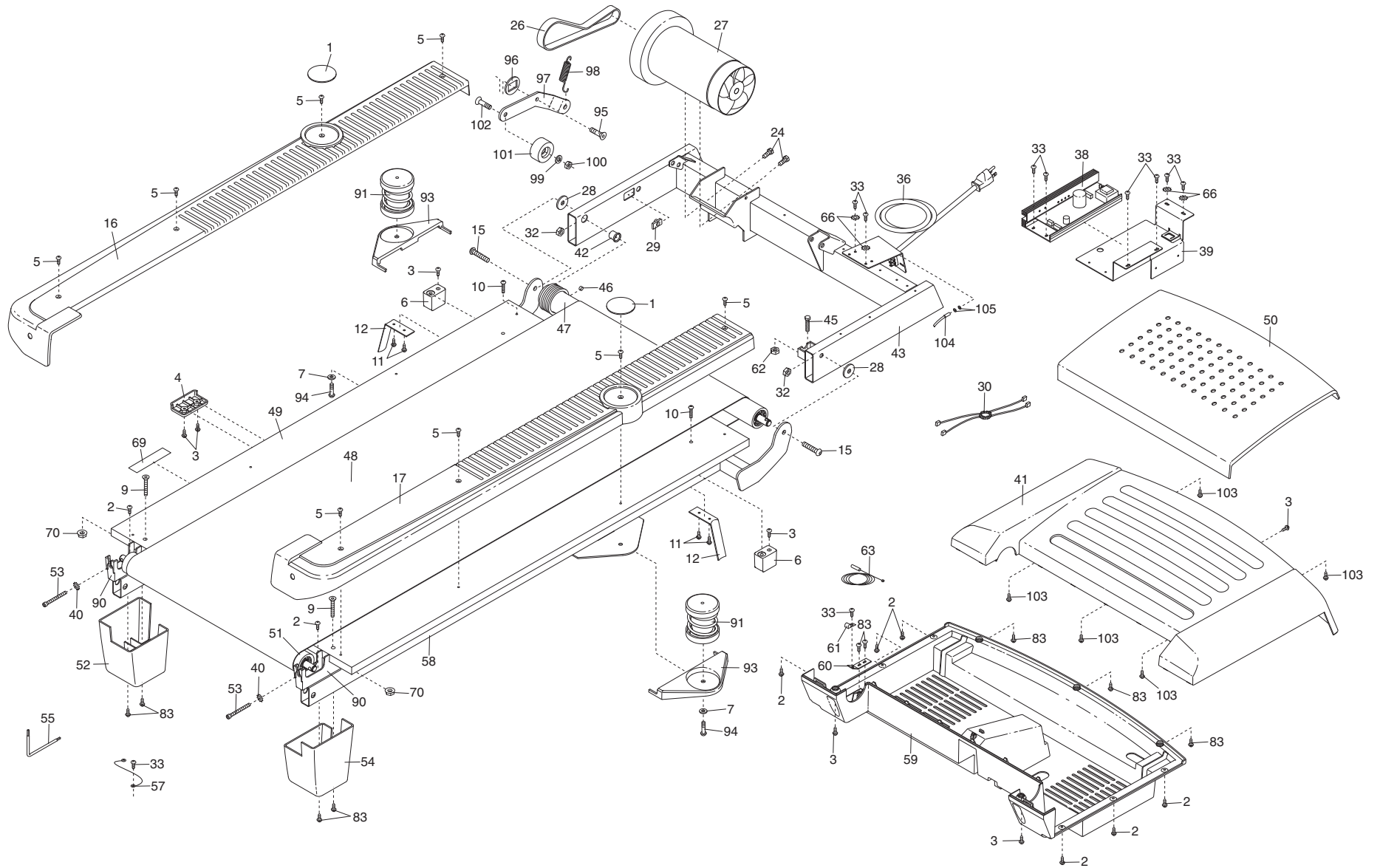

EXPLODED DRAWING—Model No. PFTL91105.0

R0506A

